



FORME OFFICE

Ind. e Com. de Mobiliário de Escritório, Lda

FormeOffice - Industria e Com. de Mobiliário de Escritório Lda

Rua do Vale da Espinheira - Cruzinha - Apartado 91

3854 - 909 Albergaria -a - Velha

PORTUGAL

Telef: 00 351 234 522 822 / 3 Fax: 00 351 234 522 848

Email: formeoffice@mail.telepac.pt

Site: www.formeoffice.com

CADEIRAS

CHAIRS | CHAISES | CHAIRS | STÜHLE

ANGEL **72** AULA **152** AVIOR **144** BUBBLES **36** COSY **118**
COT **44** EGG **110** EIGHT **148** ESCOLA **154** FLICK **24**
GABY **60** ICON **138** INFINITY **56** KAT **50** MOON **104**
NASTRO **06** NEST **120** PARIS **114** PENTA **136** PICK-C **86**
PICK-P **89** PORTUGUESA **66** STELA **98** TANGO **143**
TULIPA **140** TURMA **151** WING **94** WOOD **102**

BANCOS

TABURETES | TABOURETS | STOOLS | HOCKER

BUBBLES **43** ICON **138** MOU **124** NAO **135**
NASTRO **19** PACO **134** PENTA **136** REV **90**
SIMPSON **133** TALO **132** TANGO **143** TIM **131**

MESAS

MESAS | TABLES | TABLES | TISCHE

CAMILA **202** CRYSSALIDE **187** EIFFEL **184** ESCOLAR **206** FIRST **203**
FIXA **182** FOUR **204** FOLD **200** IRIS **201** JARRA **176**
LUXOR **188** LUXOR-M **189** OLIMPIC **180** ONDA **178** OVA **179**
PALMA **196** RAZOR **190** RING **183** STAIRS **198** STAR **194**
SLOPE **205** TAK **174** THREE **192** WOOD-M **191** XENA **186** ZONA **208**

ESTRUTURAS

ESTRUTURAS | PIÉTEMENTS | TABLE BASE | TISCHFUB

CAMILA **212** CRYSSALIDE **212** EIFFEL **212** ESCOLAR **212** FIRST **212**
FIXA **212** FOUR **212** IRIS **213** LUXOR **213** LUXOR-M **213**
OLIMPIC **213** ONDA **213** OVA **213** PALMA **213 / 214** RAZOR **214**
RING **214** STAIRS **214** STAR **214** SLOPE **214** TAK **214**
THREE **214** WOOD-M **215** XENA **215** ZONA **215**

COMPLEMENTOS

SUPLEMENTOS | SUPPLÉMENTS | SUPPLEMENTS | ERGÄNZUNGEN

CARRINHO **217** DISPENSER ALCOHOL GEL **218**
FLICK **164** GABY **166** NASTRO **158**

TAMPOS

TABLEROS | PLATEAUX | TABLE TOPS | TISCHPLATTEN

AF **229** ALF **230** ALPVC **232** AM **238** BOIS DEBOUT **227**
COMPACT **241** FENIX **234** LCM **240** MONOCHROM **235**
M23 | M31 **231** NATURAL WOOD **226** NATURAL WOOD VINTAGE **224**
TOPPLUS **242** TOPSLIM **233**

ACABAMENTOS

ACABADOS | FINITIONS | FINISHINGS | AUSFÜHRUNG **222**

let's start

Nastro



Cake Menu

CAKE FLAVORS	FROSTINGS & FILLINGS
Strawberry Cheesecake	Vanilla Cream
Chocolate Raspberry	Vanilla Custard
Apple Pie	Vanilla Cream
Blueberry	Vanilla Cream
Orange	Vanilla Cream
Key Lime	Vanilla Cream
Red Velvet	Vanilla Cream
Pumpkin	Vanilla Cream
White Chocolate	Vanilla Cream
Black Forest	Vanilla Cream
Carrot	Vanilla Cream
Almond	Vanilla Cream
Coconut	Vanilla Cream
Chocolate	Vanilla Cream
Vanilla	Vanilla Cream

PASTRY SHOP

LATTE
HOT CHOCOLATE
CAPPUCCINO
TEA
ESPRESSO
PICCOLO
LONG
FLAT WHITE
LATTE
HOT CHOCOLATE
CAPPUCCINO
TEA

ONE INDIA
APARTMENTS





Nastro



Nastro



Ref. 001



Ref. 004



Ref. 005



Ref. 006



Ref. 007



Ref. 008M



Ref. 009



Ref. 010

Cores // Colores // Couleurs // Colors // Farben



REF.	H	A	H	H	H	Box	Kg
001	86	55	52	45	4	0,33 / 3	4,65
004	86	55	52	45	-	0,25 / 2	4,90
005	86	55	52	45	4	0,33 / 4	6,40
006	86	53	54	45	4	0,29 / 2	5,70
007	86	48	52	45	-	0,25 / 2	4,50
008M	86	48	52	45	-	0,25 / 2	4
009	86	48	52	45	-	0,25 / 1	5,60
010	86	45	52	45	-	0,25 / 1	13,40



Nastro



Nastro





Nastro





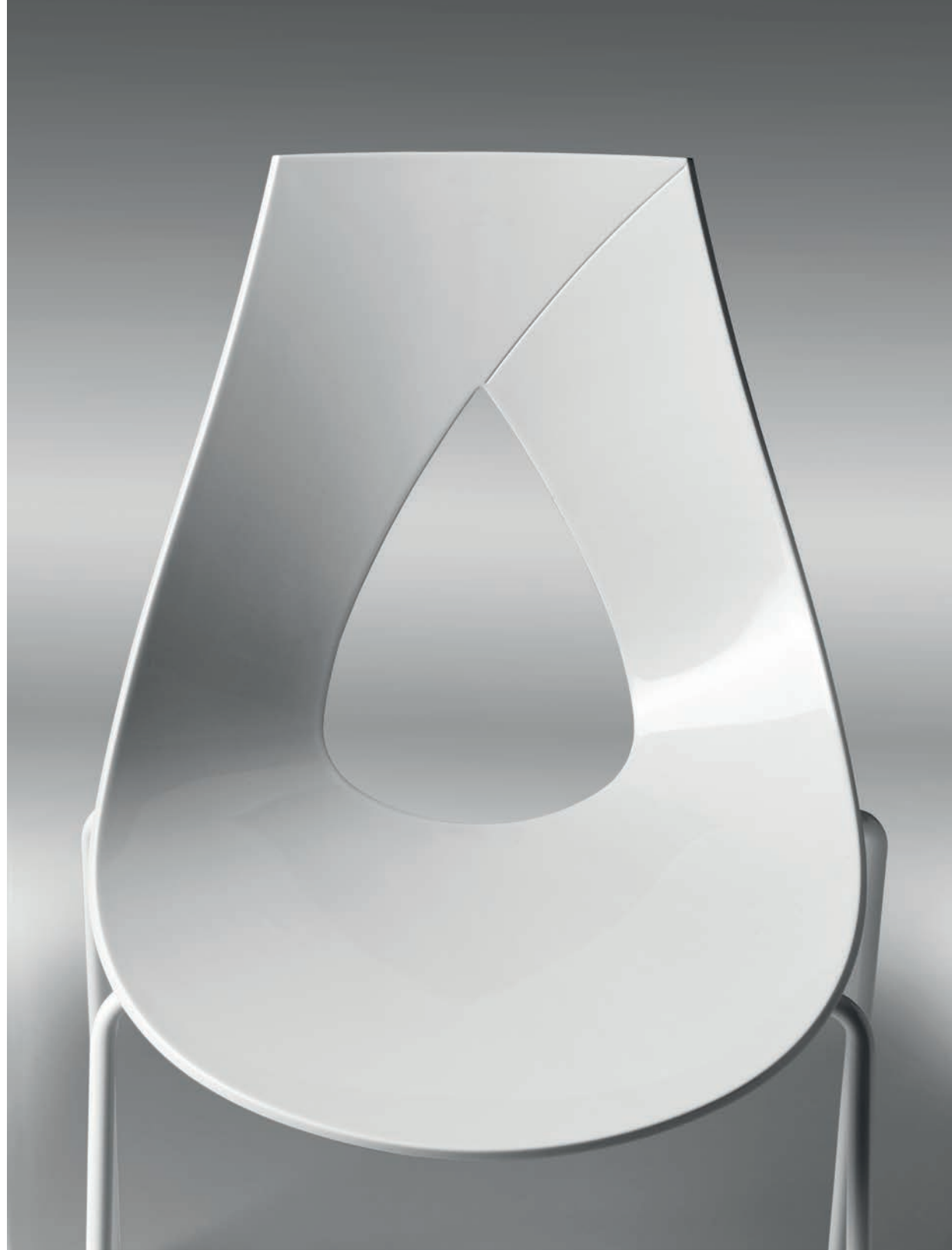

Nastro



Ref. 011



Ref. 021



Ref. 024



Ref. 025



Ref. 026



Ref. 027



Ref. 018M



Ref. 028M

Cores // Colores // Couleurs // Colors // Farben



REF.	H	A	H	H	H	kg	kg
011	83	52	44	65	3	0,25 / 2	5,15
018M	83	47	45	65	1	0,25 / 1	4,10
021	93	52	47	75	3	0,25 / 2	5,25
024	93	42	47	75	-	0,25 / 1	5,70
025	93	42	46	75	-	0,25 / 1	18,10
026	94	42	46	75	-	0,25 / 1	13,40
027	72/97	42	46	55/80	-	0,25 / 1	15,80
028M	93	51	49	75	-	0,25 / 1	3,80

Flick





Flick



Flick



Flick



Flick



Ref. 001



Ref. 005



Ref. 007



Ref. 008M



Ref. 009



Ref. 010

your
choice

Cores // Colores // Couleurs // Colors // Farben

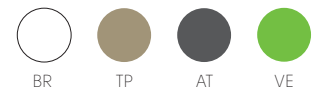

REF.	h	A	h	h	A	h	cube	kg
001	79	61	54	45	69	4	0,29 / 2	5,90
005	79	61	54	45	69	-	0,26 / 1	7,30
007	79	61	54	45	69	-	0,26 / 1	7,80
008M	79	61	54	45	69	-	0,26 / 1	5,80
009	79	61	54	45	69	-	0,26 / 1	7,30
010	79	61	54	45	69	-	0,26 / 1	15,90



Bubbles





Cores // Cores // Couleurs // Colors // Farben

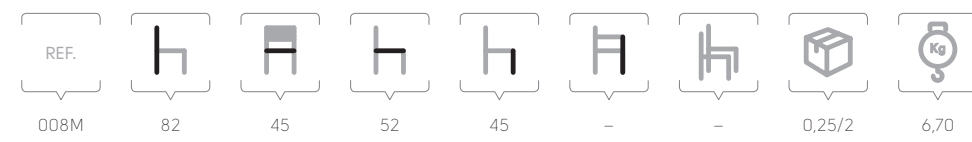
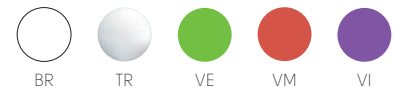

Ref. 008M

Bubbles



Cores // Colores // Couleurs // Colors // Farben

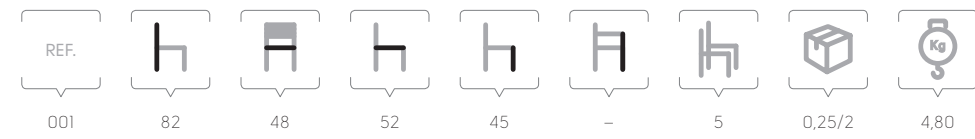
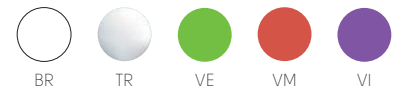

Ref. 001



Bubbles



Ref. 026



Ref. 027



Ref. 011



Ref. 021

Cores // Colores // Couleurs // Colors // Farben

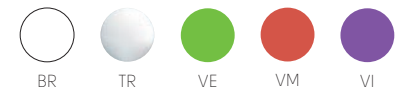

REF.	h	A	h	h	A	h	cube	Kg
002	82	53	52	45	66	3	0,32/3	6



Ref. 002

Cores // Colores // Couleurs // Colors // Farben



REF.	h	A	h	h	A	h	cube	Kg
011	102	46	58	65	-	-	0,25 / 1	6,80
021	112	46	58	75	-	-	0,37 / 1	7
026	112	46	58	75	-	-	0,25 / 1	16
027	95/120	45	58	57/82	-	-	0,25 / 1	18,50



Cot





Cot



Cot



Cores // Cores // Couleurs // Colors // Farben



Ref. BR

Ref. PR

Ref. BR/PR

Ref. BR/VM

Ref. BR/VI



Ref.001



Ref.005



Ref.006



Ref.009

REF.	h	A	h	h	A	h	kg	kg
001	80	59	56	45	64	2	0,29 / 2	7
005	80	59	56	45	64	-	0,29 / 1	7,40
006	80	59	56	45	64	-	0,26 / 1	8,20
009	80	59	56	45	64	-	0,26 / 1	6

Kat



Kat





Cores // Colores // Couleurs // Colors // Farben

BR
 CN
 PR



Ref. 002



Ref. 008M

REF.	H	A	H	H	H	Box	Kg
002	88	55	56	46	-	0,29 / 1	9,80
008M	88	55	56	46	-	0,29 / 1	6,30

Infinity

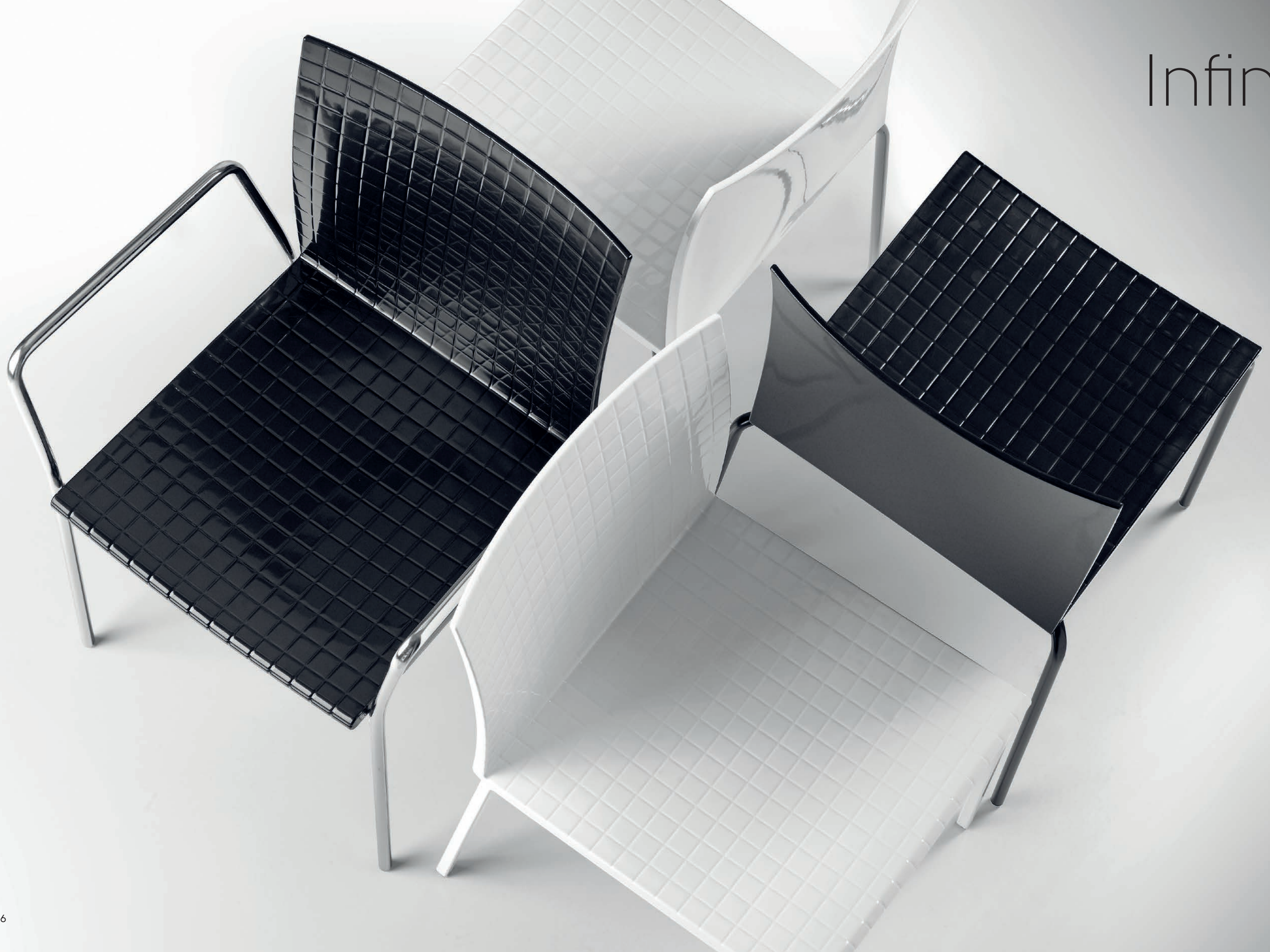

Infinity



Ref. 001



Ref. 002



Ref. 003

Cores // Colores // Couleurs // Colors // Farben

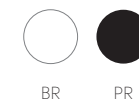

REF.	h	A	h	h	A	h	kg	kg
001	82	50	52	45	-	5	0,32 / 3	6
002	82	45	52	45	68	-	0,25 / 2	6,20
003	82	53	52	45	-	5	0,32 / 3	6,40

Gaby



The Coffee

Gaby



Gaby



Ref. 001

Ref. 003

Ref. 006

REF.	h	A	h	h	h	h	h
001	81	50	52	45	4	0,32 / 3	5,30
003	81	50	52	45	4	0,25 / 3	4,70
006	81	50	52	45	4	0,32 / 3	6

Cores // Colores // Couleurs // Colors // Farben

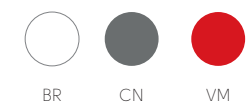

let's play



Portuguesa



Portuguesa



Ref. 001

REF.									
001	71	52	58	44	70	5	0.35/3	6	





Angel





Angel





Ref. 002

Cores // Colores // Couleurs // Colors // Farben

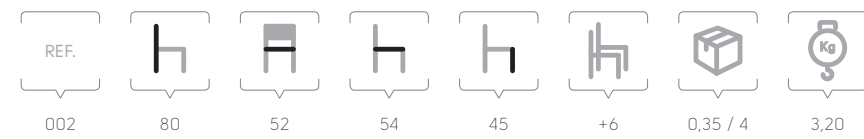



Angel



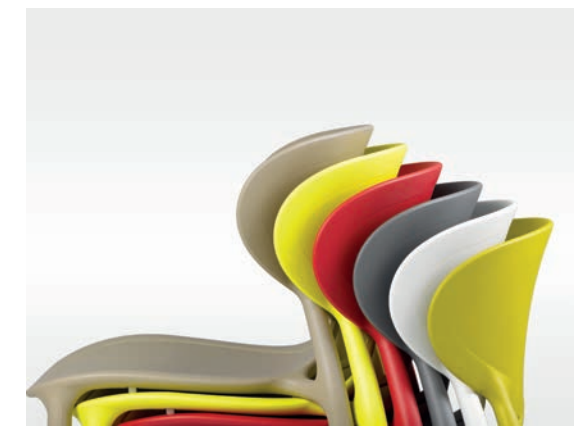

Cores // Colores // Couleurs // Colors // Farben



BR TP AT VM VE AM

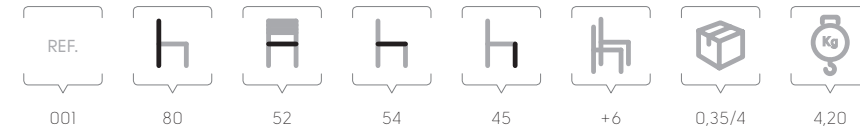

001 80 52 54 45 +6 0,35/4 4,20

Ref. 001

Pick-C



Ref. 001

REF.							
001	85	66	58	43	-	0,32 / 1	8,10

Cores // Colores // Couleurs // Colors // Farben





let's
chat

Pick-P



Ref. 001

REF.	h	A	h	h	h	cube	kg
001	-	44	-	43	-	0,22 / 2	2,70

Cores // Colores // Couleurs // Colors // Farben



Rev



Rev



Cores // Colores // Couleurs // Colors // Farben

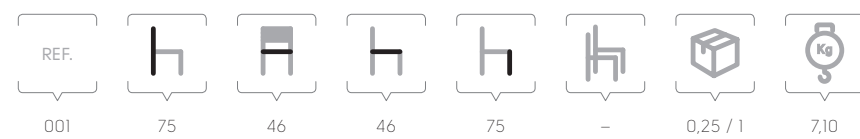

Ref. 001

Wing





really
true



Ref. 001



Ref. 005



Ref. 006



Ref. 009

REF.									
001	80	53	52	45	64	-	0,27 / 1	5.90	
005	80	53	52	45	64	-	0,27 / 1	8.20	
006	80	53	52	45	64	-	0,27 / 1	10	
009	83	53	52	45	64	-	0,29 / 1	8.20	



Stela



Stela



REF.	h	A	h	h	h	⊞	kg
001	84	58	60	45	-	0,29 / 1	6,50
007	84	58	60	45	-	0,29 / 1	6,60



Ref. 001

Ref. 007

Wood



REF.						
008M	81	47	49	45	-	0,25 / 2



Ref. 008M

Moon



REF.								
004M	82	46	53	45	-	0,32 / 2	5	



Ref. 004M

Moon



Moon



REF.							
008M	82	46	53	45	-	0,32 / 2	4,30



Ref. 008M

Egg



Egg



Ref. 001



Ref. 002



Ref. 005



Ref. 006



Ref. 008M

REF.	H	A	H	H	H	Box	kg
001	82	49	58	46	-	0,37 / 2	7
002	82	49	58	46	-	0,37 / 2	6,30
005	82	49	58	46	-	0,37 / 2	6,90
006	82	49	58	46	-	0,37 / 2	8,20
008M	82	49	58	46	-	0,37 / 2	5,90



Paris





Paris



Ref. 001

REF.												
001	88	45	57	48	-	0,25/2	8,5					



Cosy



Ref. 001

Ref. 008M

REF.	h	A	h	h	h	h	h	kg
001	86	50	57	46	-	0,29 / 1	8,60	
008M	86	50	57	46	-	0,29 / 1	8,50	

Nest



Ref. 001



Ref. 008M

REF.	h	A	h	h	A	h	cube	kg
001	80	60	59	46	73	-	0,27 / 1	10
008M	80	60	59	46	73	-	0,27 / 1	9,90

Nest





Mou





Mou



Ref. 024



Ref. 026



Ref. 027



Cores // Colores // Couleurs // Colors // Farben



REF.	h	A	h	h	h	kg	kg
024	88	55	42	75	-	0,22 / 1	6,30
026	88	55	42	75	-	0,25 / 1	14,70
027	65 / 90	55	42	54 / 80	-	0,25 / 1	15,90

Tim

stay
high



REF.	h	A	h	h	h	kg
018M	70	44	45	70	0,29 / 2	4
028M	80	46	49	80	0,30 / 2	3,6

Talo

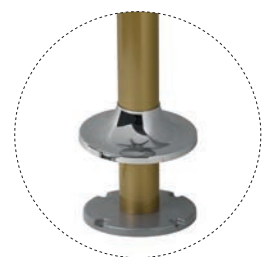

Ref. 025 ↻

REF.						
025	76	40	40	76	0,13 / 1	9,60

Simpson



Ref. 025M ↻



Ref. 025E ↻

REF.						
025E 025M	76 76	40 40	40 40	76 76	0,22 / 1 0,22 / 1	19 19

Paco



Ref. 023

REF.						
023	76	37	37	76	0,13 / 1	10,30

Nao



Ref. 013

Ref. 023

REF.						
013 023	86 98	44 44	48 48	64 76	0,25 / 1 0,25 / 1	7,40 7,90

Penta



Ref. 025

Ref. 022



Ref. 002

REF.	H	A	H	H	H	Icon	Icon
002	82	50	49	45	-	0,32 / 3	5,30
022	101	43	45	75	-	0,22 / 1	6
025	101	43	45	75	-	0,22 / 1	24,30

Icon



Ref. 022



Ref. 002



Ref. 025



REF.								
002	79	51	49	45	-	0,37 / 4	5,20	
022	103	49	44	75	-	0,22 / 1	6,70	
025	103	49	44	75	-	0,22 / 1	23,50	



Tulipa



REF.							
001	87	42	51	46	3	0,25 / 3	4,40



Ref. 001

let's
meet

Tango



Ref. 001



Ref. 021

REF.	H	A	H	H	H	Box	Kg
001	85	40	47	45	-	0,37 / 4	5,20
021	75	40	40	75	-	0,22 / 2	5,40

Avior



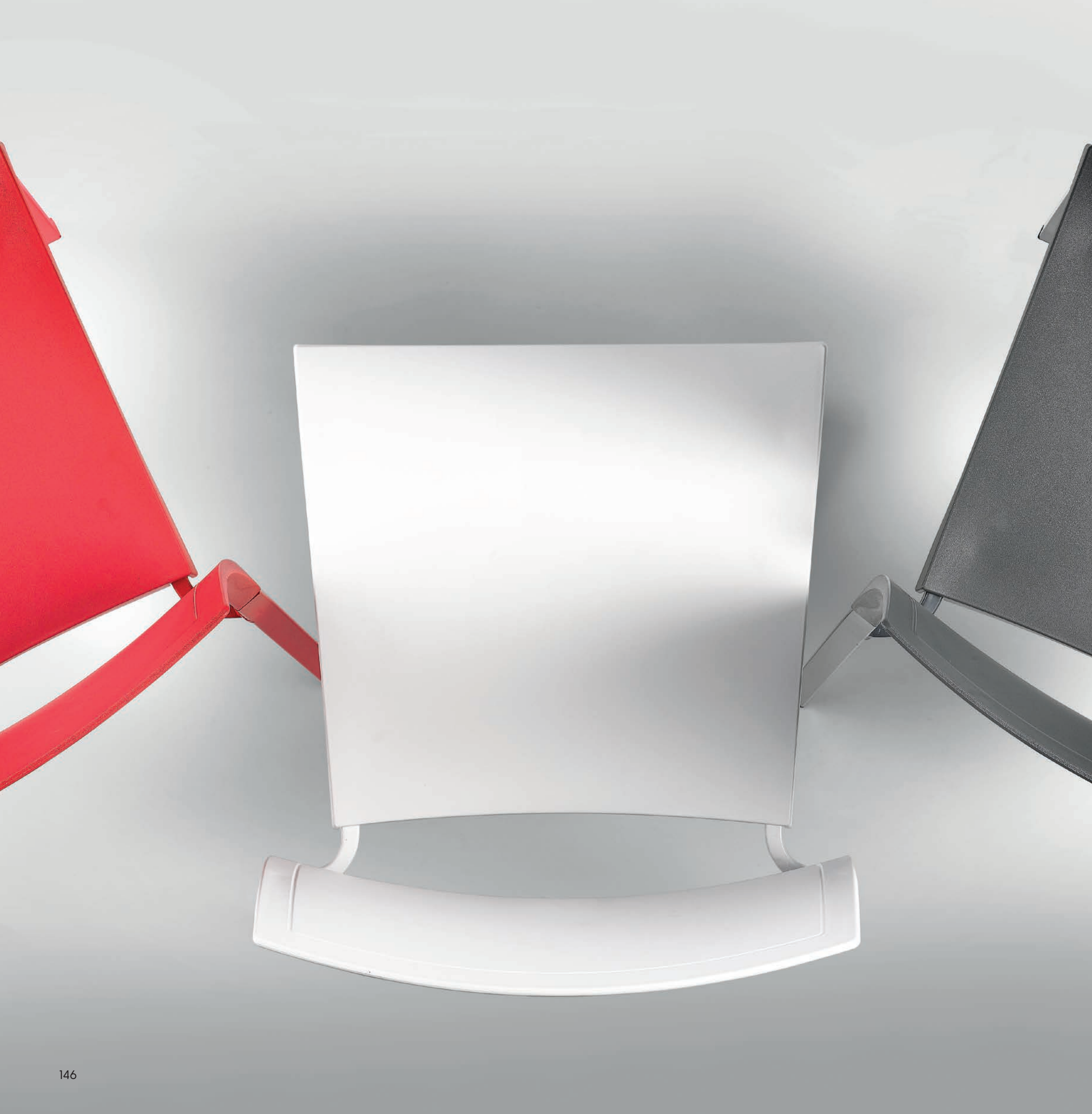

Ref. 003

Cores // Colores // Couleurs // Colors // Farben

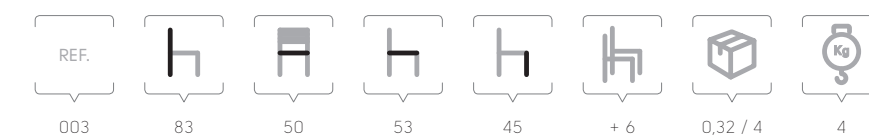

Eight



Ref. 001



Ref. 006

REF.								
001	87	53	53	46	4	0,32 / 3	4	
006	87	50	54	46	4	0,32 / 2	4,90	

Cores // Colores // Couleurs // Colors // Farben



Turma

so
simple



Cores // Colores // Couleurs // Colors // Farben



Ref. 001

Ref. 006

REF.	H	A	H	H	H	Box	Kg
001	63	38	37	37	+ 6	0,22 / 7	2,10
006	63	40	39	37	+ 4	0,25 / 6	2,40



Aula



Ref. 001



Ref. 006

Cores // Colores // Couleurs // Colors // Farben



REF.	h	A	h	h	h	h	h
001	76	46	53	45	+ 6	0,25 / 4	2,90
006	75	50	50	46	4	0,32 / 3	4,10



Escola



REF.							
001	80	43	49	45	6	0,25/3	3,70
002	70	42	42	38	6	0,25/5	3,20



Ref. 001

Ref. 002

Nastro

YOU ARE IN
FIRST FLOOR
C
1
OB TRIAGE
LOBBY C
MATERNAL FETAL
MEDICINE CENTER
CHILDREN'S
EMERGENCY
ADULT
EMERGENCY



Nastro



Nastro

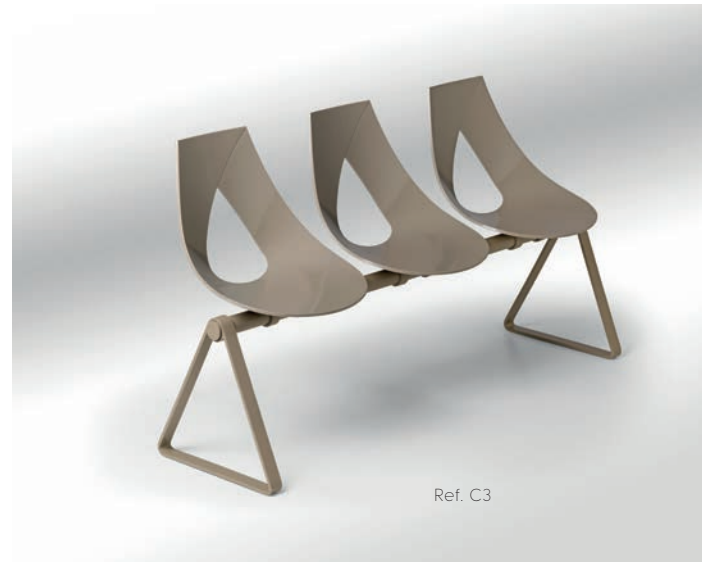

Ref. C3



Ref. C2

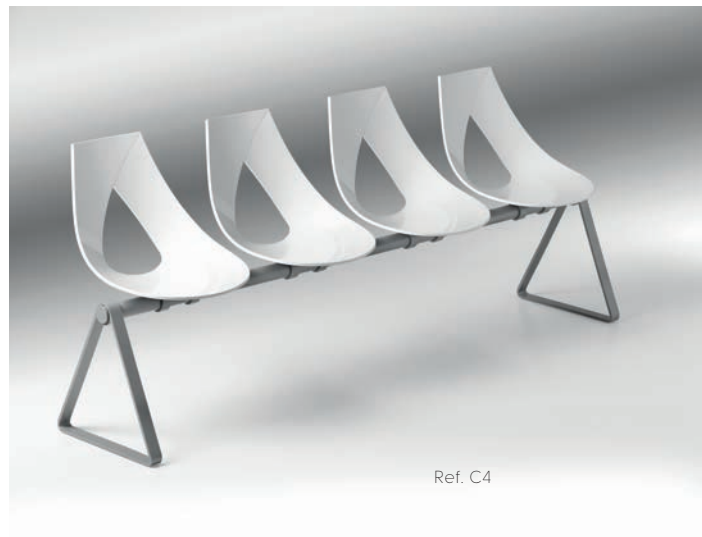

Ref. C4



Ref. CA4



Ref. C5

REF.						
C2	85	105	56	45	0,58	23
C3	85	158	56	45	0,87	29
C4	85	212	56	45	1,15	32,5
C5	85	264	56	45	1,43	36
CA2	85	105	56	45	0,58	15,5
CA3	85	158	56	45	0,87	21,5
CA4	85	212	56	45	1,15	25
CA5	85	264	56	45	1,43	28,5

Cores // Cores // Couleurs // Colors // Farben

BR
 TP
 AT
 PR
 VE
 VI

Flick



Ref. C2



Ref. CA4

Cores // Colores // Couleurs // Colors // Farben



REF.	h	A	h	h	kg	kg
C2	78	130	54	45	0,64	26
C3	78	195	54	45	0,95	33,5
C4	78	260	54	45	1,26	38,5
CA2	78	130	54	45	0,64	18,5
CA3	78	195	54	45	0,95	26
CA4	78	260	54	45	1,26	31



Ref. C3



Gaby



Ref. CA2



Ref. CA5



Ref. CA3



Ref. CA4

REF.	h	A	h	h	kg	kg
CA2	83	102	56	45	0,55	18,5
CA3	83	152	56	45	0,81	26
CA4	83	202	56	45	1,08	31
CA5	83	152	56	45	1,34	36

Cores // Colores // Couleurs // Colors // Farben

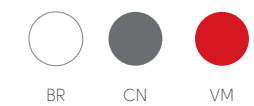

Gaby

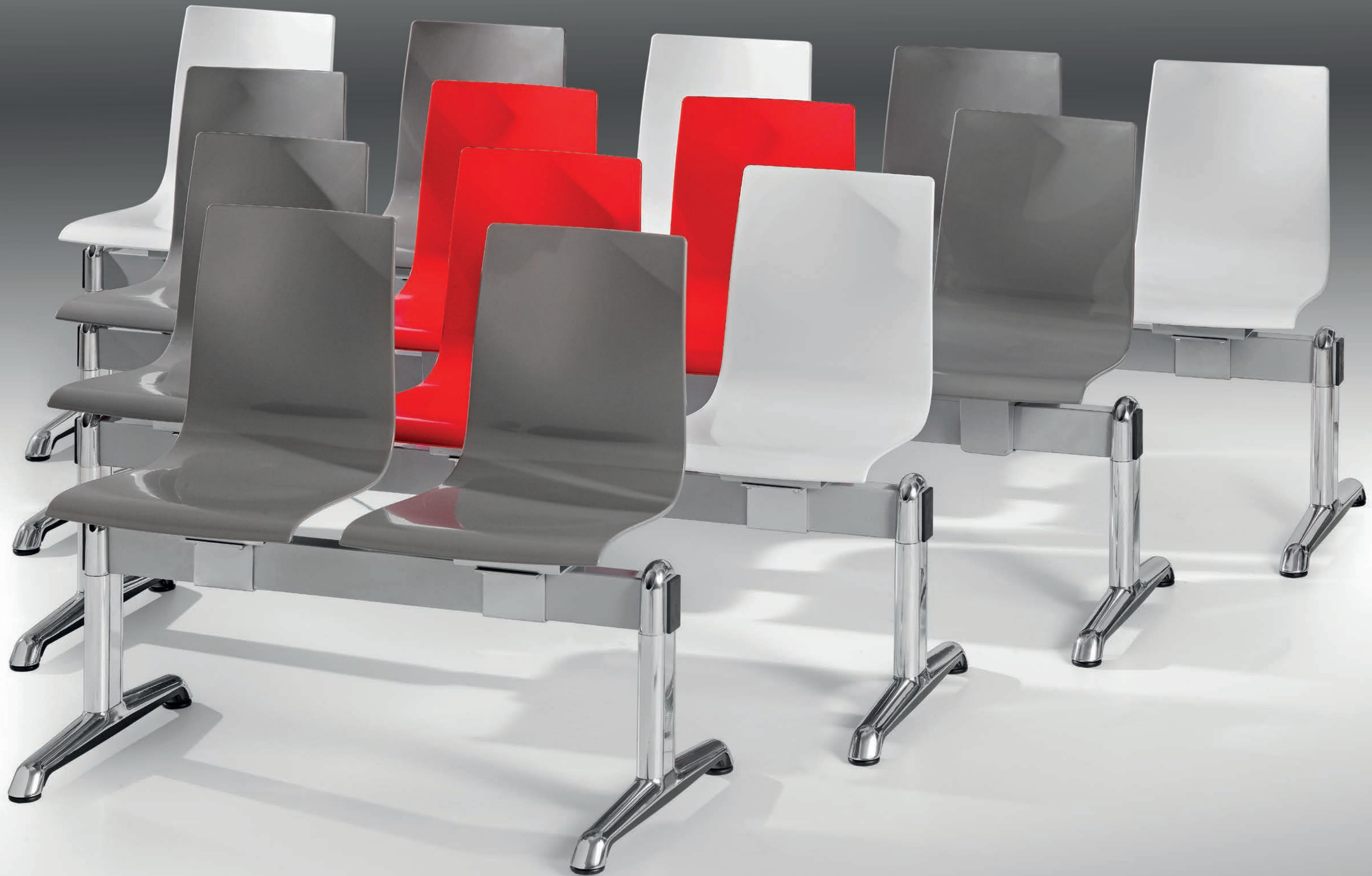

Gaby



Ref. CN2



Ref. CN3



Ref. CN5



Ref. CN4



REF.						
CN2	83	102	56	45	0,55	25
CN3	83	152	56	45	0,81	32
CN4	83	202	56	45	1,08	37
CN5	83	252	56	45	1,34	41

Cores // Colores // Couleurs // Colors // Farben

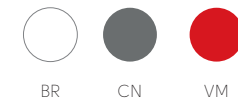

let's talk



REF. TAK 001
 Ø 400
 -
 Ø 800 - 700X700
 730
 0,12 / 1
 8,1



Ref. 001



Tak

Jarra



Cores // Colores // Couleurs // Colors // Farben



Ref. 001

REF.	I	I	I	I	☐	⚖
JARRA 001	Ø 270	-	Ø 700	750	0,29 / 2	9

Onda



REF.
ONDA 070

Ø 700

-

Ø 1300

730

0,36 / 1

13



Ref. 070

Ova



REF.
OVA 084

800X400

Ø 60

1600X800

730

0,25 / 1

30



Ref. 084

Olimpic



Ref. 070



Ref. 150



Ref. 050

REF.	I	I	I	I		
OLIMPIC 050	Ø 500	Ø 50	Ø 900	730	0,15 / 1	11
OLIMPIC 070	Ø 700	Ø 60	Ø 1300	730	0,15 / 1	14,5
OLIMPIC 150	Ø 500	Ø 50	Ø 700	1080	0,20 / 1	12



Fixa

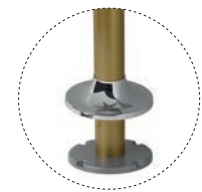

Ref. 011



Ref. 001

REF.						
FIXA 001	Ø 235	Ø 80	700X700	730	0,05 / 1	10,5
FIXA 011	Ø 235	Ø 80	700X700	1080	0,07 / 1	12

Ring



REF.						
RING 060	Ø 600	Ø 76	Ø 1200	730	0,10 / 1	26



Ref. 060

Eiffel



Ref. 012



Ref. 002



Ref. 003

REF.	Table Dimensions	Leg Diameter	Table Height	Table Width	Table Depth	Weight
EIFFEL 002	430X430	Ø 16	730	700X700	730	7,5
EIFFEL 003	1080X430	Ø 16	730	1200X800	730	9,5
EIFFEL 012	430X430	Ø 16	1080	600X600	1080	8,5

Xena



Ref. 003

Ref. 012

Ref. 002

REF.	Table Top	Leg Diameter	Table Dimensions	Table Height	Weight	Weight
XENA 002	400X400	Ø 50	700X700	730	0,12 / 1	7,5
XENA 003	940X400	Ø 50	1200X700	730	0,28 / 1	14
XENA 012	400X400	Ø 50	600X600	1080	0,18 / 1	8,5

Crystalide



Ref. 001

REF.	Table Top	Leg Diameter	Table Dimensions	Table Height	Weight	Weight
CRYSSALIDE 001	Ø 640	-	Ø 700	730	0,30 / 1	11,5

Luxor



Ref. 001



Ref. 002



Ref. 003

REF.	Ø	Ø	Ø	H	Volume	Weight
LUXOR 001	Ø 580	Ø 80	Ø 700	730	0,15 / 1	5,8
LUXOR 002	450X450	Ø 80	800X800	730	0,15 / 1	7,6
LUXOR 003	960X530	Ø 80	1200X800	730	0,38 / 1	12,5

Luxor-M



Ref. 001



Ref. 002



Ref. 003

REF.	Ø	Ø	Ø	H	Volume	Weight
LUXOR-M 001	Ø 580	Ø 80	Ø 700	730	0,15 / 1	5,6
LUXOR-M 002	450X450	Ø 80	800X800	730	0,15 / 1	7,4
LUXOR-M 003	960X530	Ø 80	1200X800	730	0,38 / 1	11,7

Razor



Ref. 003

REF.	I	I	I	I	☐	⚖
RAZOR 003	1400X800	-	1400X800	730	0,35 / 1	38

Wood-M



Ref. 002



Ref. 003

REF.	I	I	I	I	☐	⚖
WOOD-M 002 WOOD-M 003	700X700 - 800X800 1200X700 - 1200X800	- -	700X700 - 800X800 1200X700 - 1200X800	730 730	0,45 / 1 0,70 / 1	9 - 11 12 - 14

Three



REF.	I	I	I	I		
THREE 001	Ø 660	Ø 60	Ø 800 - 700X700	730	0,32 / 1	13,5
THREE 011	Ø 660	Ø 60	Ø 700 - 600X600	1080	0,40 / 1	14,5



Ref. 011

Ref. 001



Star



Ref. 001

Ref. 011

REF.							
STAR 001	Ø 450	Ø 70	Ø 900	730	0,32 / 1	20,5	
STAR 011	Ø 450	Ø 70	Ø 700	1080	0,40 / 1	21,5	

Star



Ref. 002

Ref. 012

REF.							
STAR 002	400X400	Ø 50	800X800	730	0,32 / 1	13,5	
STAR 012	400X400	Ø 50	600X600	1080	0,40 / 1	14,5	

Palma



Palma



Ref. 040

Ref. 048

REF.							
PALMA 040	Ø 400	Ø 80	Ø 800 - 700X700	730	0,10 / 1	14	
PALMA 048	Ø 480	Ø 80	Ø 900 - 800X800	730	0,10 / 1	18	

REF.							
PALMA 390	390X390	70X70	800X800	730	0,10 / 1	16	
PALMA 490	490X490	70X70	1000X1000	730	0,10 / 1	23,5	



Ref. 390

Ref. 490

Stairs



Ref. 040



Ref. 055

REF.
STAIRS 040
STAIRS 055

Ø 400
Ø 550

Ø 80
Ø 80

Ø 800
Ø 1000

730
730

0,15 / 1
0,15 / 1

18,6
28

Stairs



Ref. 6040



Ref. 400

REF.
STAIRS 400
STAIRS 6040

400X400
600X4000

70X70
70X70

800X800
1200X800

730
730

0,15 / 1
0,15 / 1

21,5
30,5

Fold



Ref. 003

REF.	I	I	I	I	Kg
FOLD 003	-	Ø 30	1600X800	730	11,5

Iris



Ref. 002



REF.	I	I	I	I	Kg
IRIS 002 IRIS 003	Ø 800 1000X620 / 1500X620	60X60 50X50	Ø 1400 1600X800	730 730	14 12 / 15



Ref. 003

Camila



Ref. 002



Ref. 012

REF.	Width	Depth	Tabletop	Height	Weight	Weight
CAMILA 002	480X480	50X50	700X700	730	0,18 / 1	6,3
CAMILA 012	480X480	50X50	600X600	1080	0,26 / 1	7,3

First



Ref. 002



Ref. 003

REF.	Width	Depth	Tabletop	Height	Weight	Weight
FIRST 002	410X410	Ø 38	700X700	730	0,14 / 1	3,7
FIRST 003	790X540	Ø 38	1200X800	730	0,33 / 1	9,5

Four



REF.	I	I	I	I	☐	⚖
001	800x800	Ø 50	800x800	730	0,10 / 1	11
003	1200x800	Ø 50	1200x800	730	0,15 / 1	15

Slope



REF.	I	I	I	I	☐	⚖
001	700x700	Ø 30	700x700	730	0,10 / 1	10
003	1100x700	Ø 30	1100x700	730	0,15 / 1	13

Escolar



Ref. 011



Ref. 012

REF.	Width	Depth	Length	Height	Weight
ESCOLAR 011	630X480	Ø 40	700X500	580	7,4
ESCOLAR 012	1200X480	Ø 40	1300X500	580	8,4



Ref. 021



Ref. 022

REF.	Width	Depth	Length	Height	Weight
ESCOLAR 021	630X480	Ø 40	700X500	730	8,4
ESCOLAR 022	1200X480	Ø 40	1300X500	730	9,4

Zona



fix it





Camila Ref. 002 [P. 202]



Camila Ref. 012 [P. 202]



Crysalide Ref. 001 [P. 187]

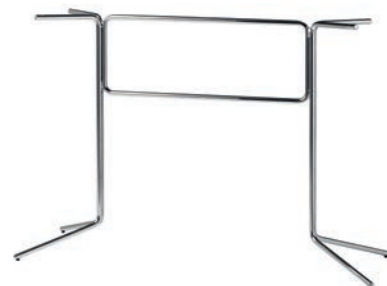

Eiffel Ref. 003 [P. 185]



Iris Ref. 002 [P. 201]



Iris Ref. 003 [P. 201]



Luxor Ref. 001 [P. 188]



Luxor Ref. 002 [P. 188]



Eiffel Ref. 002 [P. 185]



Eiffel Ref. 012 [P. 185]



Escolar Ref. 011 [P. 206]



Escolar Ref. 012 [P. 206]



Luxor Ref. 003 [P. 188]



Luxor-M Ref. 001 [P. 189]



Luxor-M Ref. 002 [P. 189]



Luxor-M Ref. 003 [P. 189]



Escolar Ref. 021 [P. 207]



Escolar Ref. 022 [P. 207]



First Ref. 002 [P. 203]



First Ref. 003 [P. 203]



Olimpic Ref. 050 [P. 180]



Olimpic Ref. 070 [P. 180]



Olimpic Ref. 150 [P. 180]



Onda Ref. 070 [P. 178]



Fixa Ref. 001 [P. 182]



Fixa Ref. 011 [P. 182]



Four Ref. 001 [P. 204]



Four Ref. 003 [P. 204]



Ova Ref. 084 [P. 179]



Palma Ref. 040 [P. 196]



Palma Ref. 048 [P. 196]



Palma Ref. 390 [P. 197]



Palma Ref. 490 [P. 197]



Razor Ref. 003 [P. 190]



Ring Ref. 060 [P. 183]



Stairs Ref. 040 [P. 198]



Stairs Ref. 055 [P. 198]



Stairs Ref. 400 [P. 199]



Stairs Ref. 6040 [P. 199]



Star Ref. 001 [P. 194]



Star Ref. 002 [P. 195]



Star Ref. 011 [P. 194]



Star Ref. 012 [P. 195]



Slope Ref. 001 [P. 205]



Slope Ref. 003 [P. 205]



Tak Ref. 001 [P. 174]



Three Ref. 001 [P. 192]



Three Ref. 011 [P. 192]



Wood-M Ref. 002 [P. 191]



Wood-M Ref. 003 [P. 191]



Xena Ref. 002 [P. 186]



Xena Ref. 003 [P. 186]



Xena Ref. 012 [P. 186]



Zona Ref. 001 [P. 209]

take
me

Carrinho





Dispenser

alcohol gel

Dispenser

alcohol gel

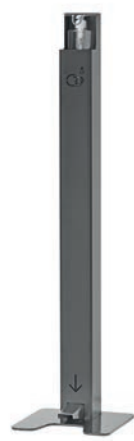

Ref. 001

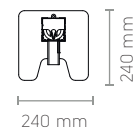
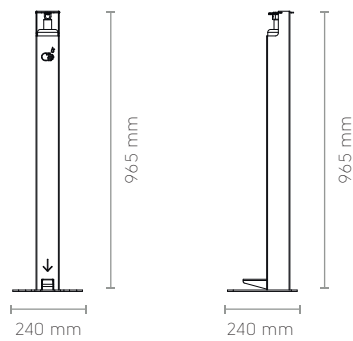

Coluna
Colonne
Column
80x80 mm

Cores // Colores // Couleurs // Colors // Farben

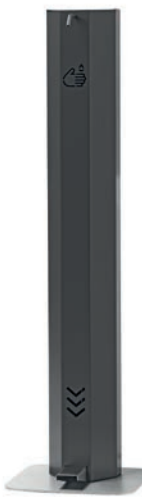

Ref. 020

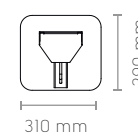
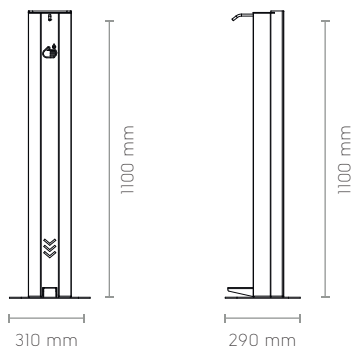

Cores // Colores // Couleurs // Colors // Farben





acabamentos

ACABADOS | FINITIONS | FINISHINGS | AUSFÜHRUNG

MADEIRA NATURAL VINTAGE

MADERA NATURAL VINTAGE | BOIS NATUREL VINTAGE | NATURAL WOOD VINTAGE | NATURHOLZ

TAMPOS | TABLEROS | PLATEAUX | TABLE TOPS | TISCHPLATTEN



PINHO • PINO • PIN • PINE • PINIE



FREIXO • FRESNO • FRÈNE • ASH • ESCHÉ



CARVALHO • ROBLE • CHÈNE • OAK • EICHE



A madeira é um material vivo e é impossível evitar a formação de fendas, fissuras ou alteração de cores. Sem responsabilização pelas alterações acima mencionadas.

Importante: La madera es un material vivo y es imposible evitar la formación de grietas o alteración de colores. No nos hacemos responsables por cualquier alteración.

Le bois est une matière vivante et il est impossible d'empêcher la formation de gerces, de fentes, de craquelures ou changements de couleur. Pas de responsabilisation par les déformations vu qu'elles sont incontrôlables.

Wood is a living material and it's impossible to prevent the formation of cracks, fissures or color changes. No liability for any deformation as they are uncontrollable.

Holz ist ein lebendiges Material und es ist nicht möglich die Bildung von Rissen oder Farbveränderungen zu verhindern. Keine Haftung für Verformungen, da diese nicht zu beeinflussen sind.

CORES VINTAGE | COLORES VINTAGE | COULEURS VINTAGE | VINTAGE COLORS | VINTAGE FARBEN



VTG101



VTG103

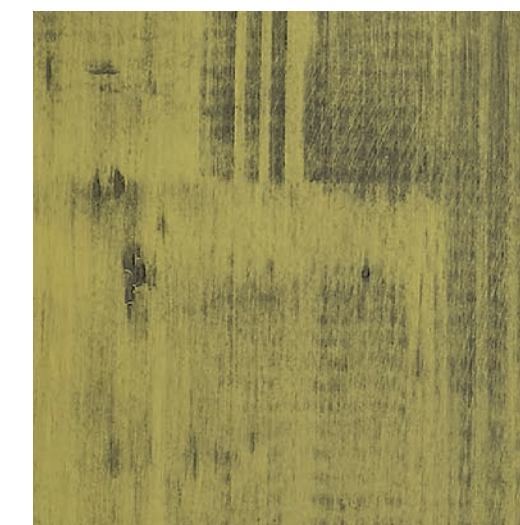

VTG105



VTG107



VTG109

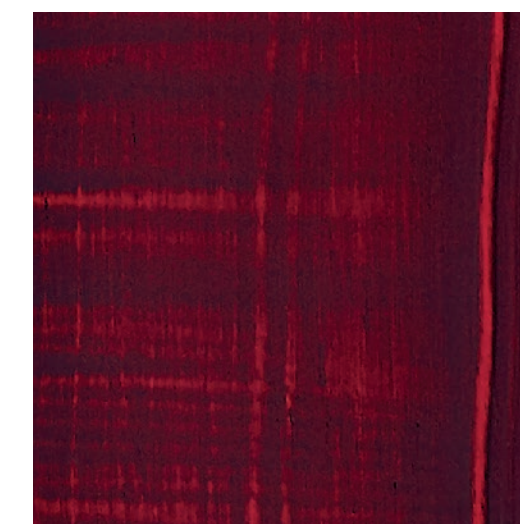

VTG112

LAMINITES | LAMINADOS | STRATIFIÉ | LAMINATE | LAMINAT

LOW COST

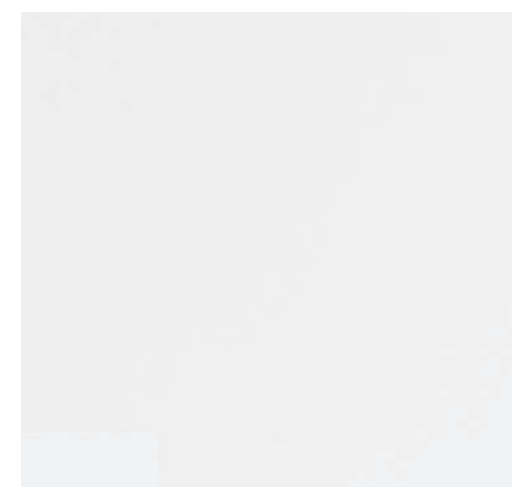

LC001



LC011

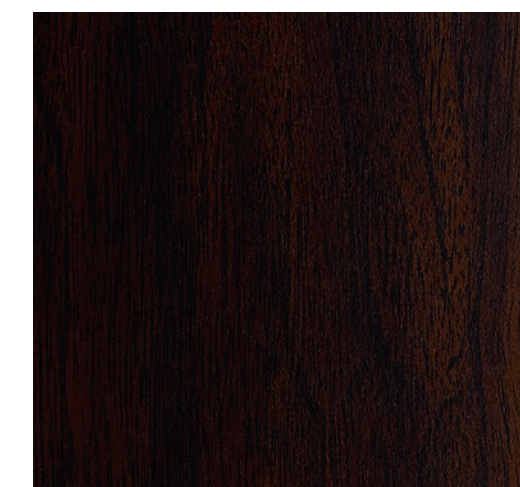

LC021

MADEIRA NATURAL

MADERA NATURAL | BOIS NATUREL | NATURAL WOOD | NATURHOLZ

TAMPOS | TABLEROS | PLATEAUX | TABLE TOPS | TISCHPLATTEN



PINHO • PINO • PIN • PINE • PINIE



FREIXO • FRESNO • FRÈNE • ASH • ESCHE



CARVALHO • ROBLE • CHÈNE • OAK • EICHE

ref. **MPN30**

Madeira Pinho
Madera Pino
Bois Pin
Wood Pine
Holz Pine

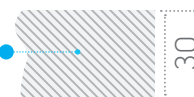

ref. **MFR30**

Madeira Freixo
Madera Fresno
Bois Frêne
Wood Ash
Holz Esche

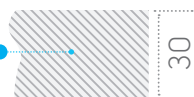

ref. **MCA30**

Madeira Carvalho
Madera Roble
Bois Chêne
Wood Oak
Holz Eiche

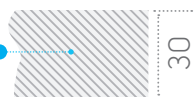

A madeira é um material vivo e é impossível evitar a formação de fendas, fissuras ou alteração de cores. Sem responsabilização pelas alterações acima mencionadas.

Importante: La madera es un material vivo y es imposible evitar la formación de grietas o alteración de colores. No nos hacemos responsables por cualquier alteración.

Le bois est une matière vivante et il est impossible d'empêcher la formation de gerces, de fentes, de craquelures ou changements de couleur.

Pas de responsabilisation par les déformations vu qu'elles sont incontrôlables.

Wood is a living material and it's impossible to prevent the formation of cracks, fissures or color changes. No liability for any deformation as they are uncontrollable.

Holz ist ein lebendiges Material und es ist nicht möglich die Bildung von Rissen oder Farbveränderungen zu verhindern. Keine Haftung für Verformungen, da diese nicht zu beeinflussen sind.

LAMINITES

LAMINADOS | STRATIFIÉ | LAMINATE | LAMINAT

TAMPOS | TABLEROS | PLATEAUX | TABLE TOPS | TISCHPLATTEN



BOIS DEBOUT



H1181 ST37



H1180 ST37



H3309 ST28



H1181 ST37 - PVC - CHANT FIL DE BOIS 30-44



H1180 ST37 - PVC - CHANT FIL DE BOIS 30-44



H3309 ST28 - PVC - CHANT FIL DE BOIS 30-44



H1181 ST37 - PVC - CHANT BOIS DEBOUT 30-44



H1180 ST37 - PVC - CHANT BOIS DEBOUT 30-44



H3309 ST28 - PVC - CHANT BOIS DEBOUT 30-44

ref. **ALBD1230**

Laminite
Laminado
Stratifié
Laminate
Laminat

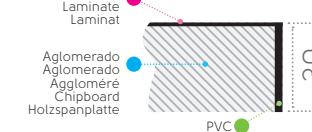

ref. **ALBD1244**

Laminite
Laminado
Stratifié
Laminate
Laminat

Aglomerado
Agglomerado
Aggloméré
Chipboard
Holzspanplatte

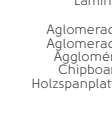



As cores e dimensões apresentadas neste catálogo são meramente indicativas
 Los colores y dimensiones presentados en el catálogo son solamente para ejemplificación
 Les couleurs et dimensions présentées dans le catalogue sont seulement pour exemplification
 The colours and dimensions presented in the catalogue are just exemplifying
 Die farben und größen im katalog sind nur exemplarisch

AF

TAMPOS | TABLEROS | PLATEAUX | TABLE TOPS | TISCHPLATTEN

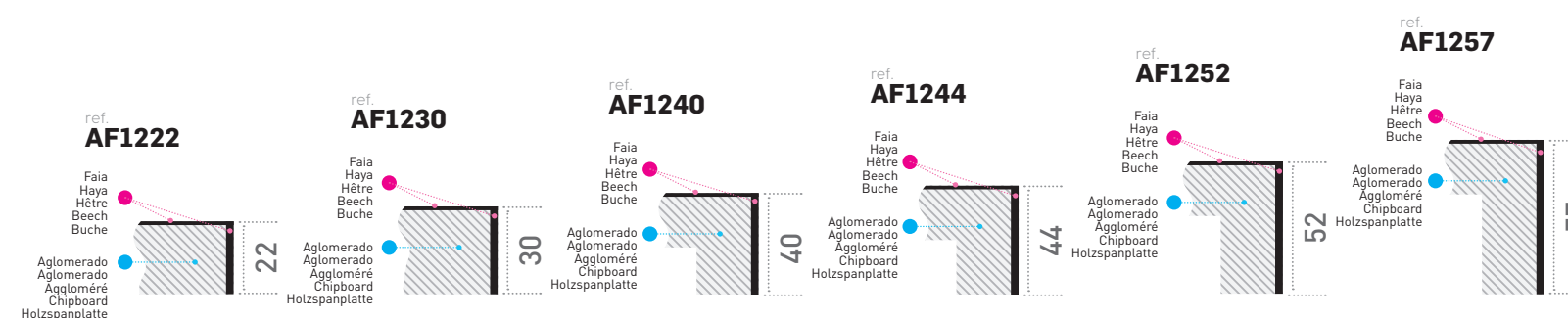

FAIA VELATURA | HAYA CON COLOR | HÊTRE TEINTÉ | STAINED BEECH | BUCHE GEBEITZT

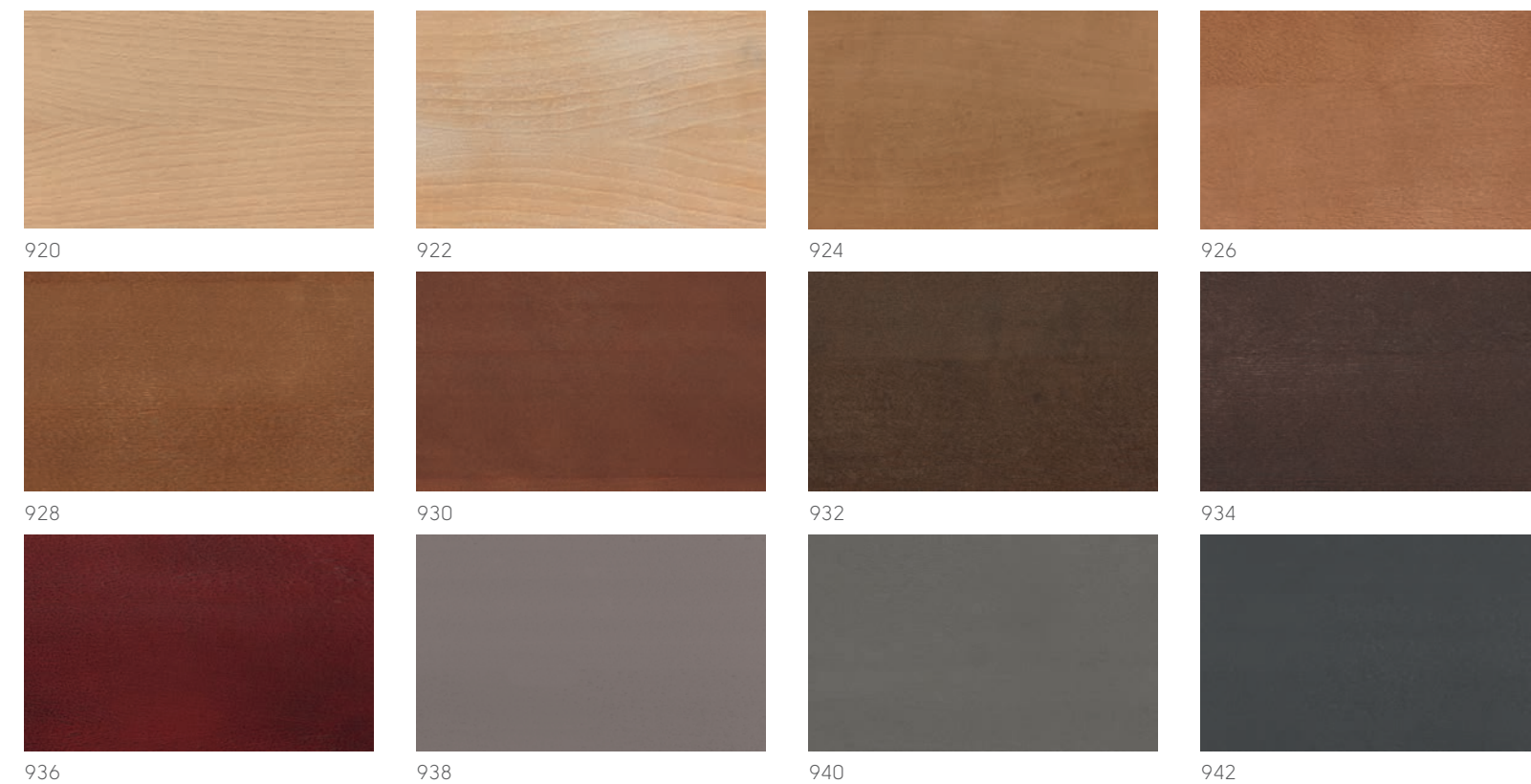



M23 TAMPOS | TABLEROS | PLATEAUX | TABLE TOPS | TISCHPLATTEN

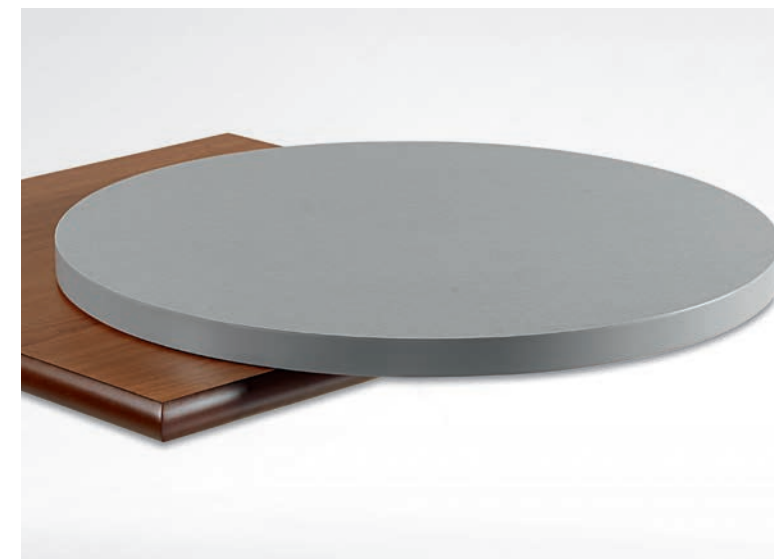
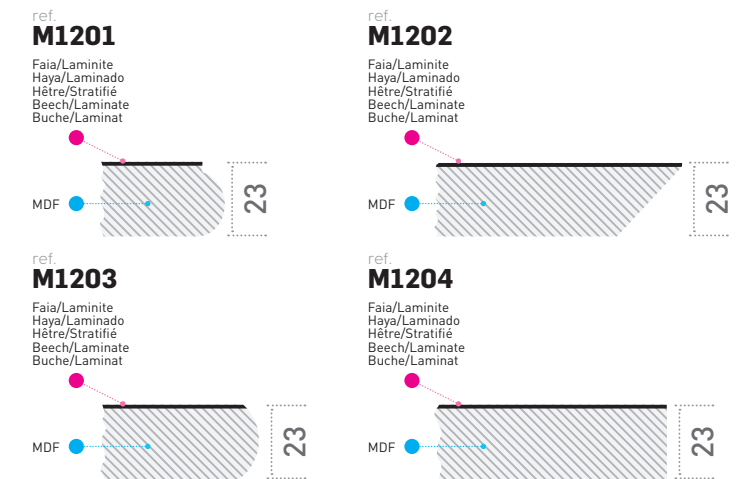

M31 TAMPOS | TABLEROS | PLATEAUX | TABLE TOPS | TISCHPLATTEN



FAIA VELATURA | HAYA CON COLOR | HÊTRE TEINTÉ | STAINED BEECH | BUCHE GEBEITZT

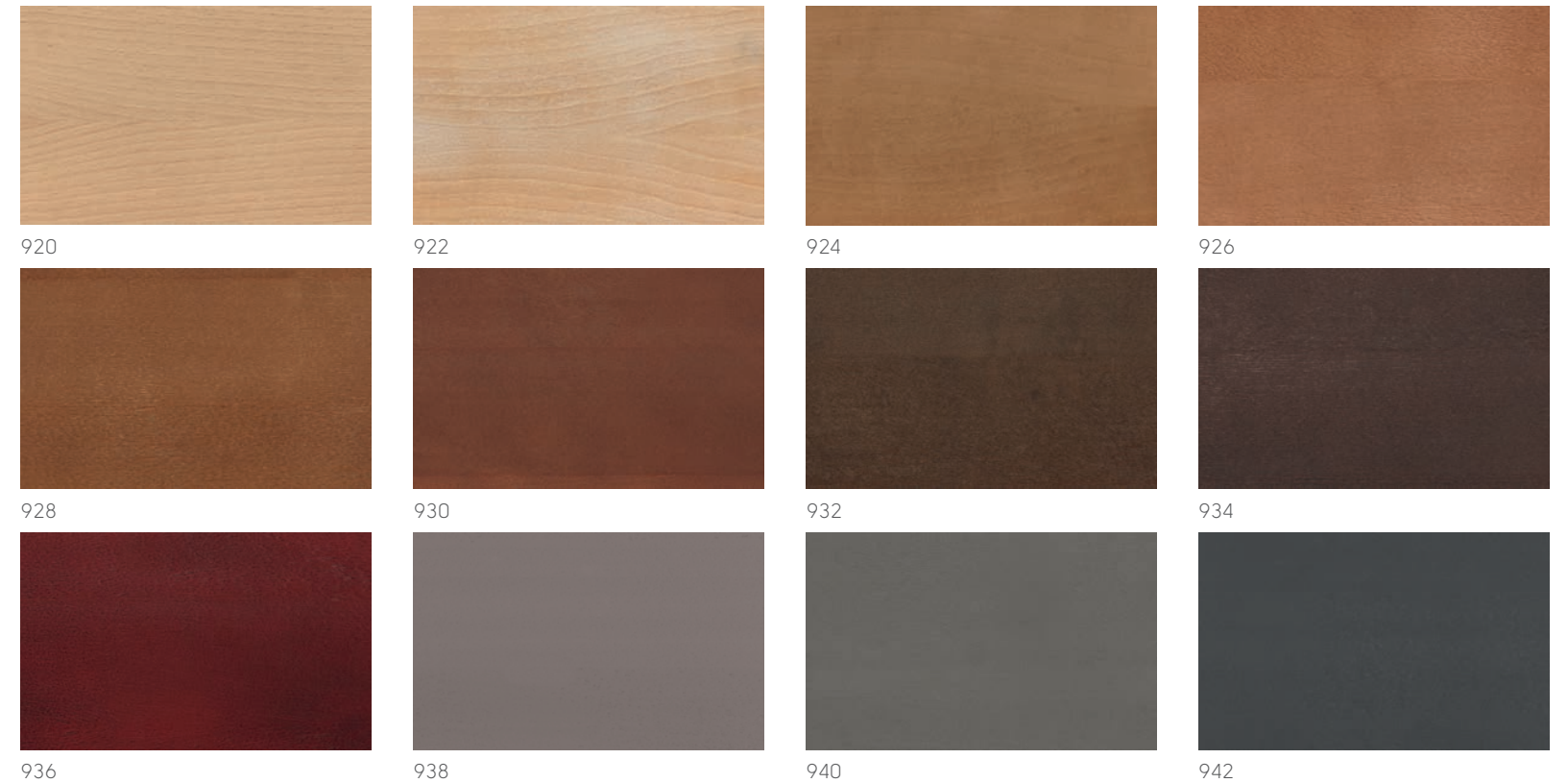

ALF

TAMPOS | TABLEROS | PLATEAUX | TABLE TOPS | TISCHPLATTEN

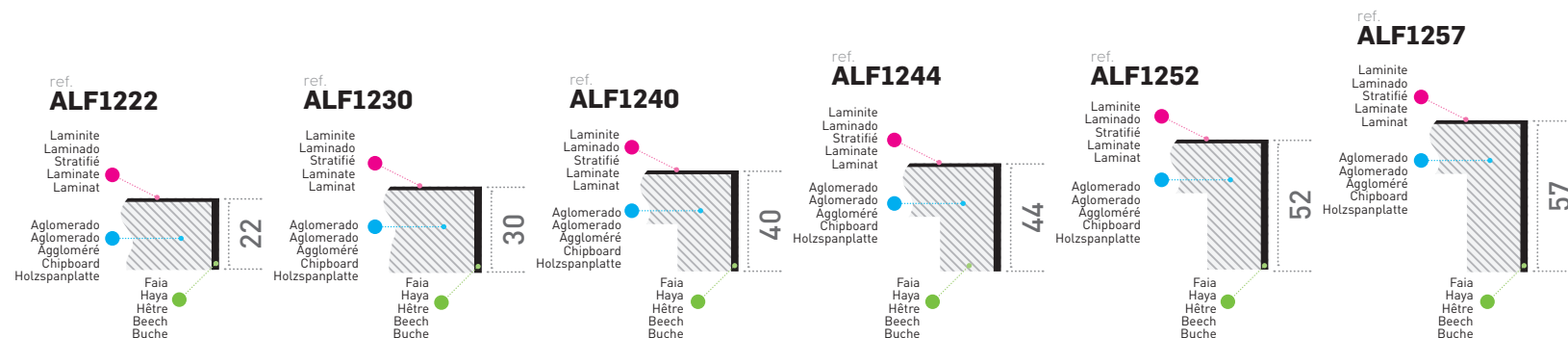



ALPVC

TAMPOS | TABLEROS | PLATEAUX | TABLE TOPS | TISCHPLATTEN

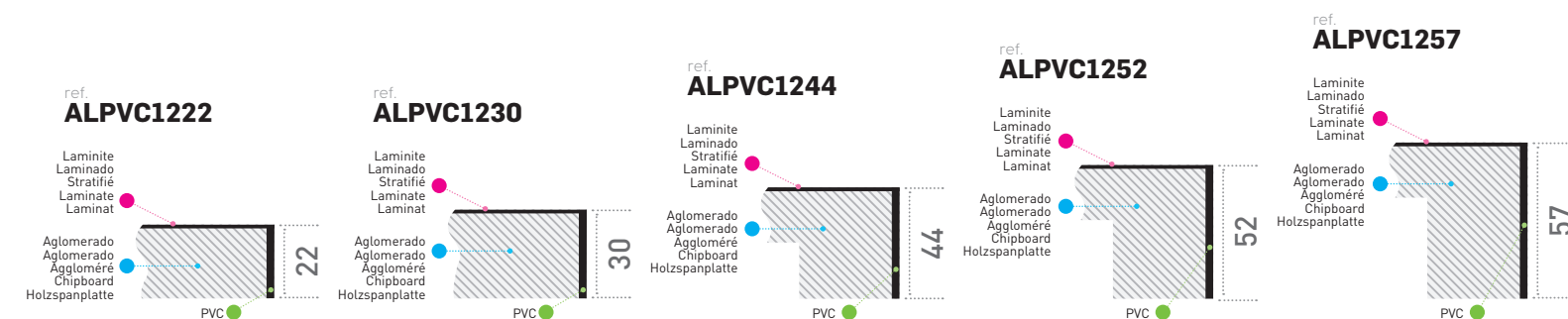

TOPSLIM

by redi

TAMPOS | TABLEROS | PLATEAUX | TABLE TOPS | TISCHPLATTEN



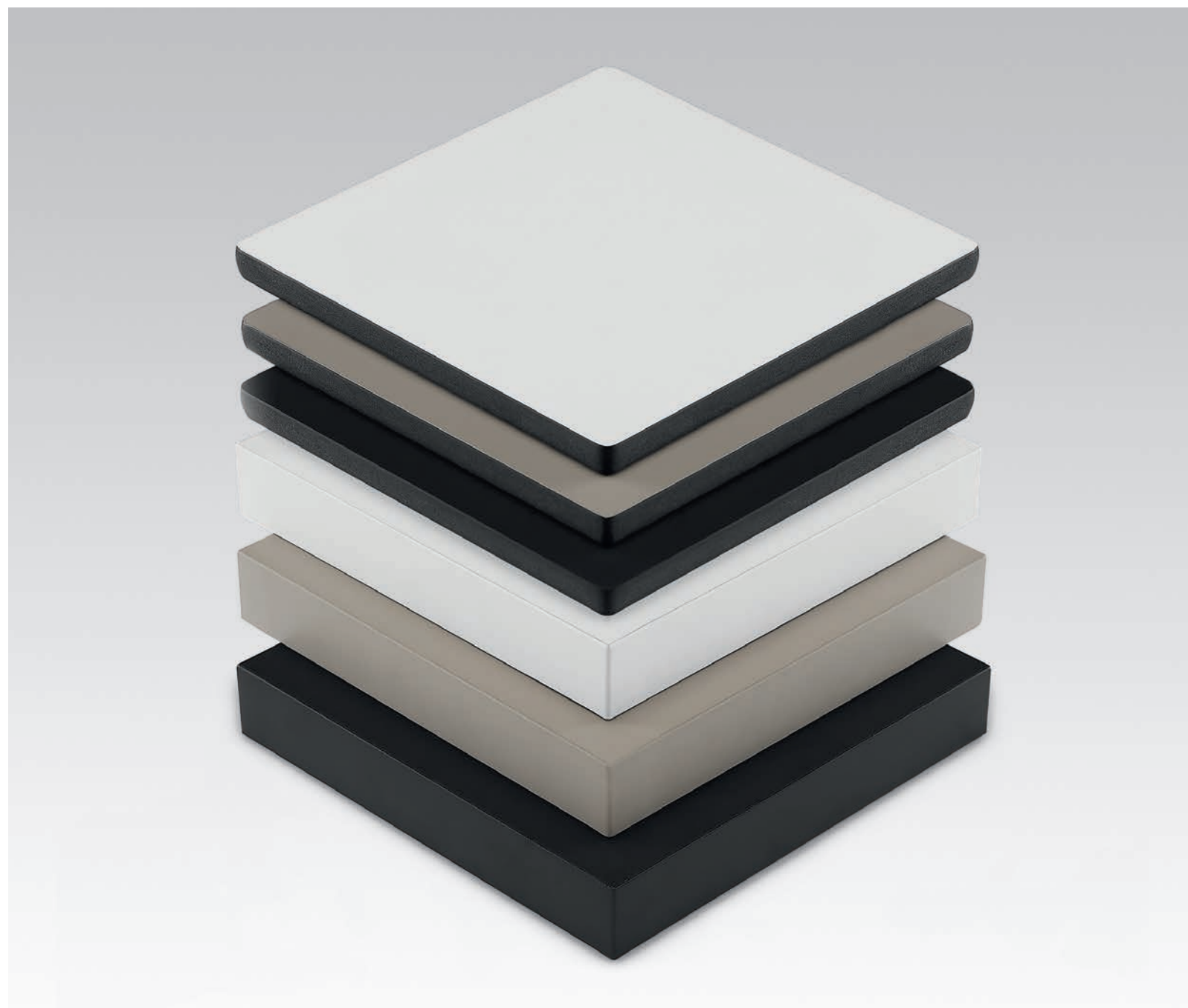

FENIX

TAMPOS | TABLEROS | PLATEAUX |
TABLE TOPS | TISCHPLATTEN

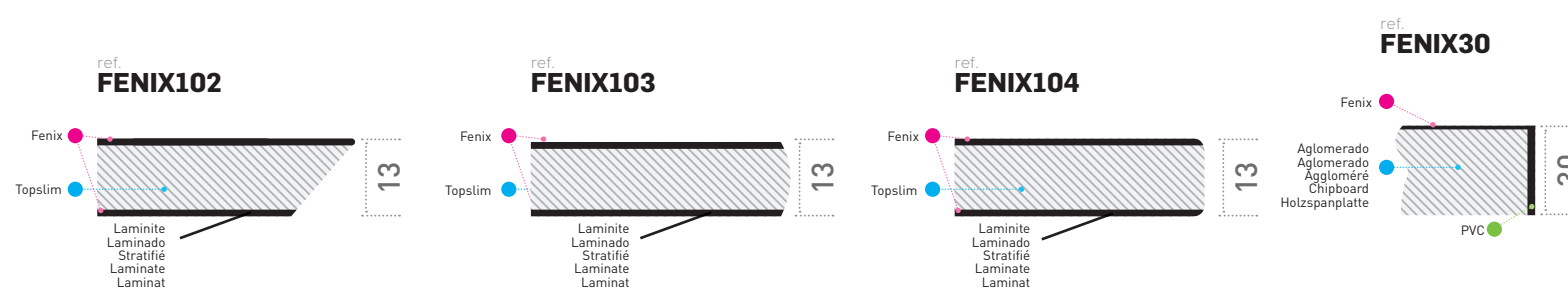

MONOCHROM

TAMPOS | TABLEROS | PLATEAUX | TABLE TOPS | TISCHPLATTEN



LAMINITES | LAMINADOS | STRATIFIÉ | LAMINATE | LAMINAT

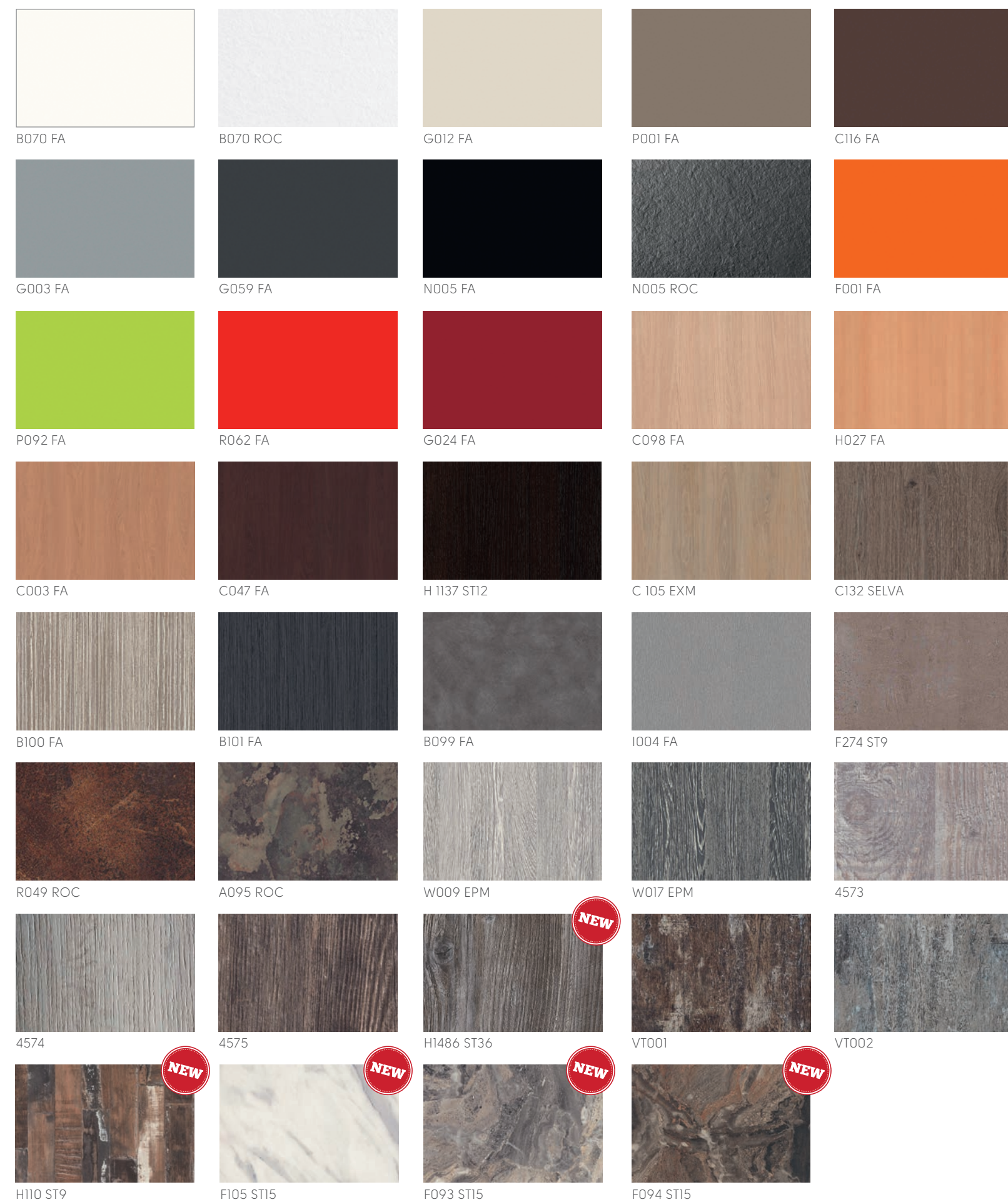

PVC | PVC | PVC | PVC | PVC

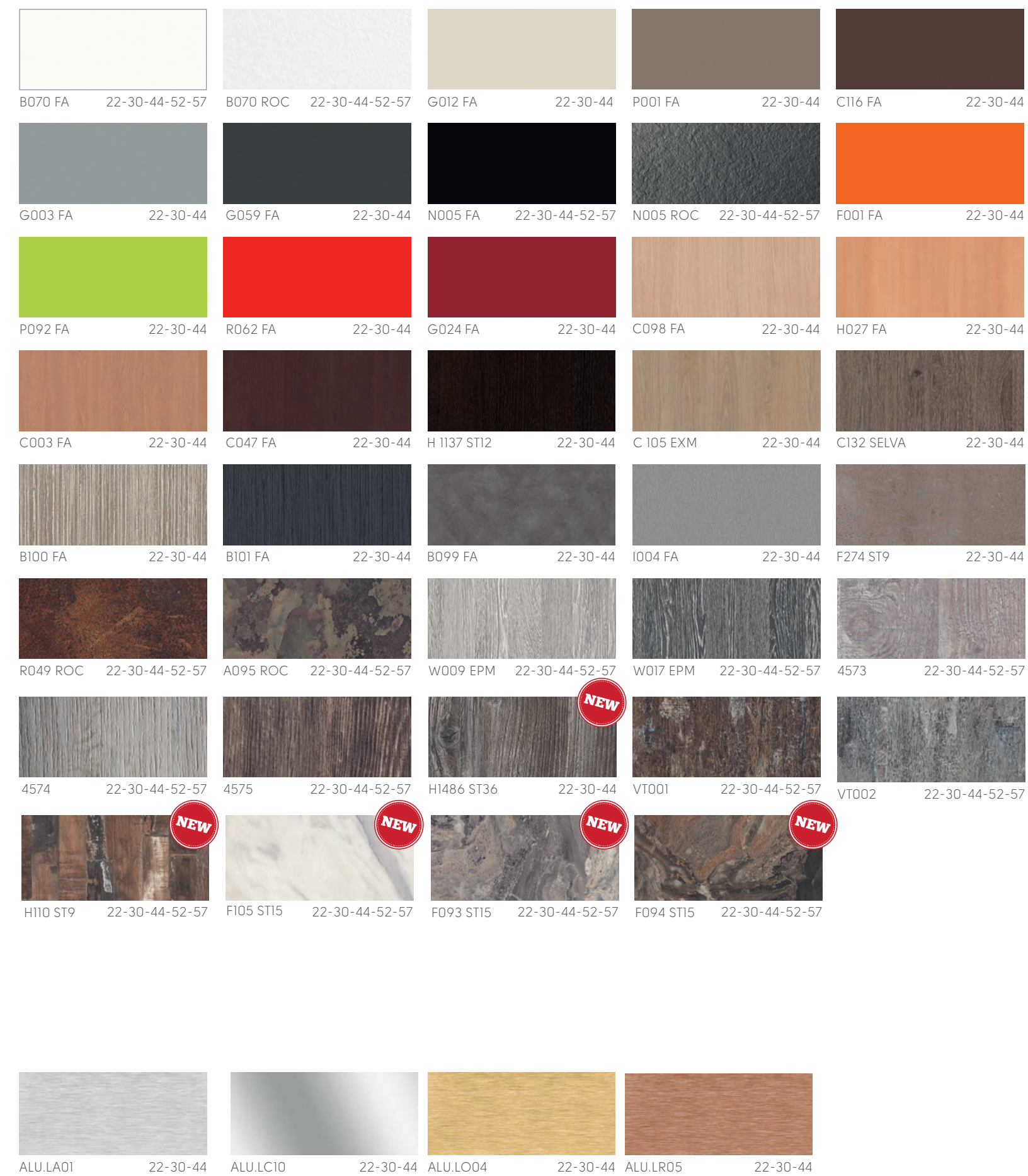



AM - 19mm

TAMPOS
TABLEROS
PLATEAUX
TABLE TOPS
TISCHPLATTEN

ref.
AM1219

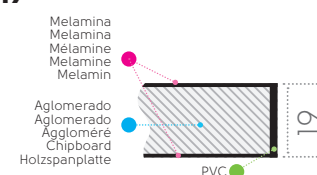

MELAMINA | MELAMINA | MÉLAMINE | MELAMINE | MELAMIN



U763 ST9 ①

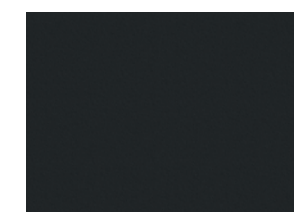

U961 ST2 ①

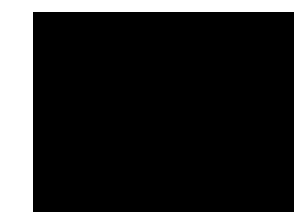

U999 ST2 ①

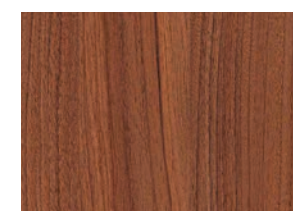

H3734 ST9 ③



H1334 ST9 ②



H1137 ST12 ②



H1582 ST15 ③

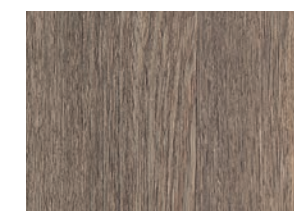

H1115 ST15 ③



AM - 38mm

TAMPOS
TABLEROS
PLATEAUX
TABLE TOPS
TISCHPLATTEN

ref.
AM1238

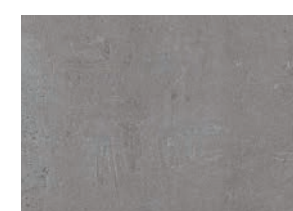
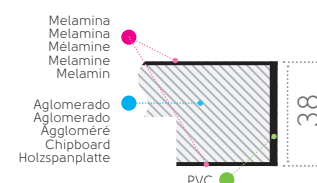

F274 ST9 ③

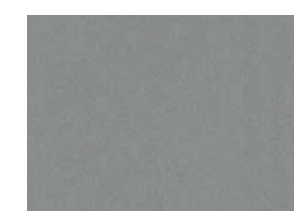

F509 ST2 ③



4298 ③

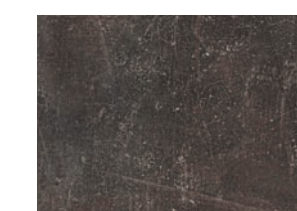

4299 ③

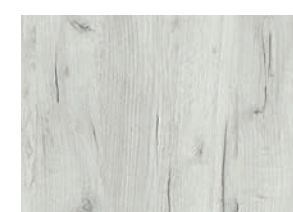

K001 ③



K002 ③

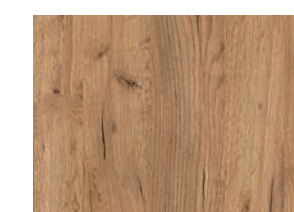

K003 ③

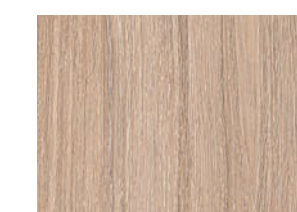

K005 ③

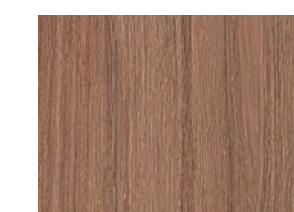

K007 ③

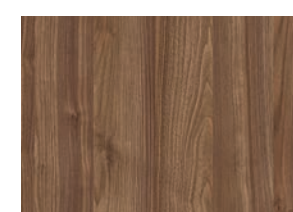

K009 ③

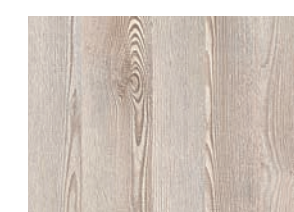

K010 ③



K011 ③

TAMPOS EM MELAMINA | TABLEROS EN MELAMINA | PLATEAUX EN MELAMINE | TOPS IN MELAMINE | MELAMIN TISCHPLATTEN



LCM - 19mm

TAMPOS | TABLEROS | PLATEAUX | TABLE TOPS | TISCHPLATTEN

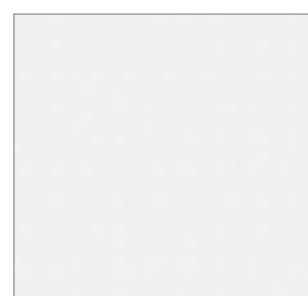
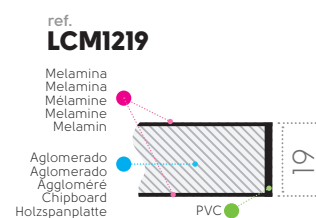

W908 ST2

TAMPOS EM MELAMINA | TABLEROS EN MELAMINA | PLATEAUX EN MELAMINE | TOPS IN MELAMINE | MELAMIN TISCHPLATTEN



LCM - 38mm

TAMPOS | TABLEROS | PLATEAUX | TABLE TOPS | TISCHPLATTEN

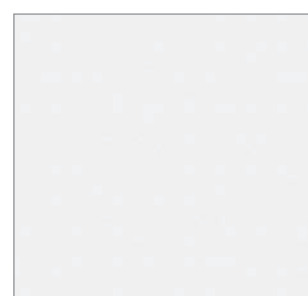
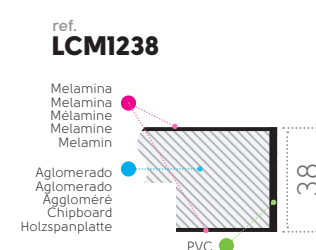

W908 ST2

COMPACT

TAMPOS | TABLEROS | PLATEAUX | TABLE TOPS | TISCHPLATTEN

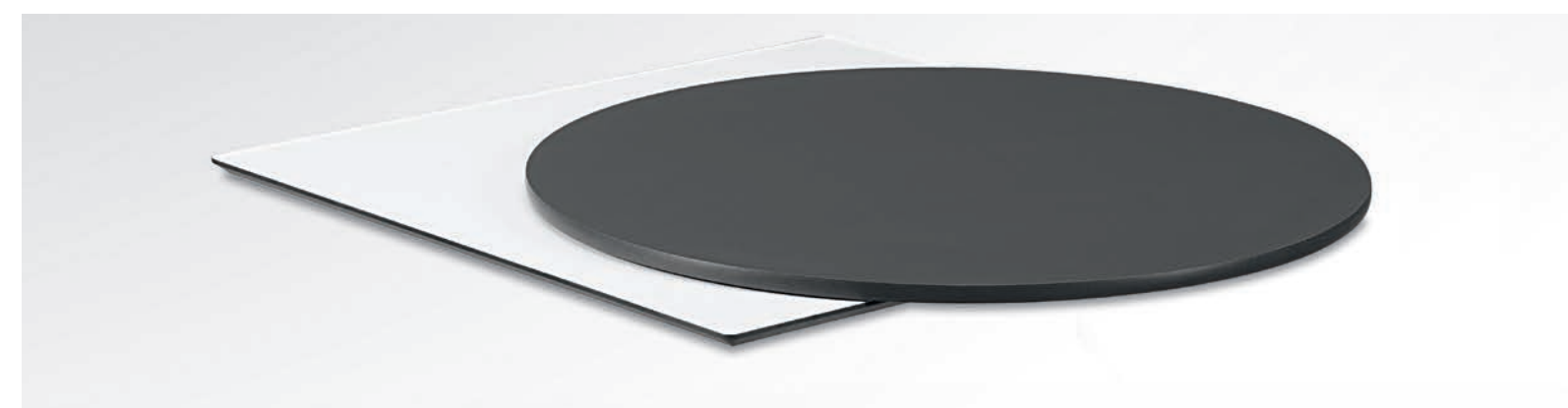

COMPACT | COMPACT | COMPACT | COMPACT | KOMPAKTPLATTE

INTERIOR | INTERIOR | INTÉRIEUR | INDOOR | INNENBEREICH

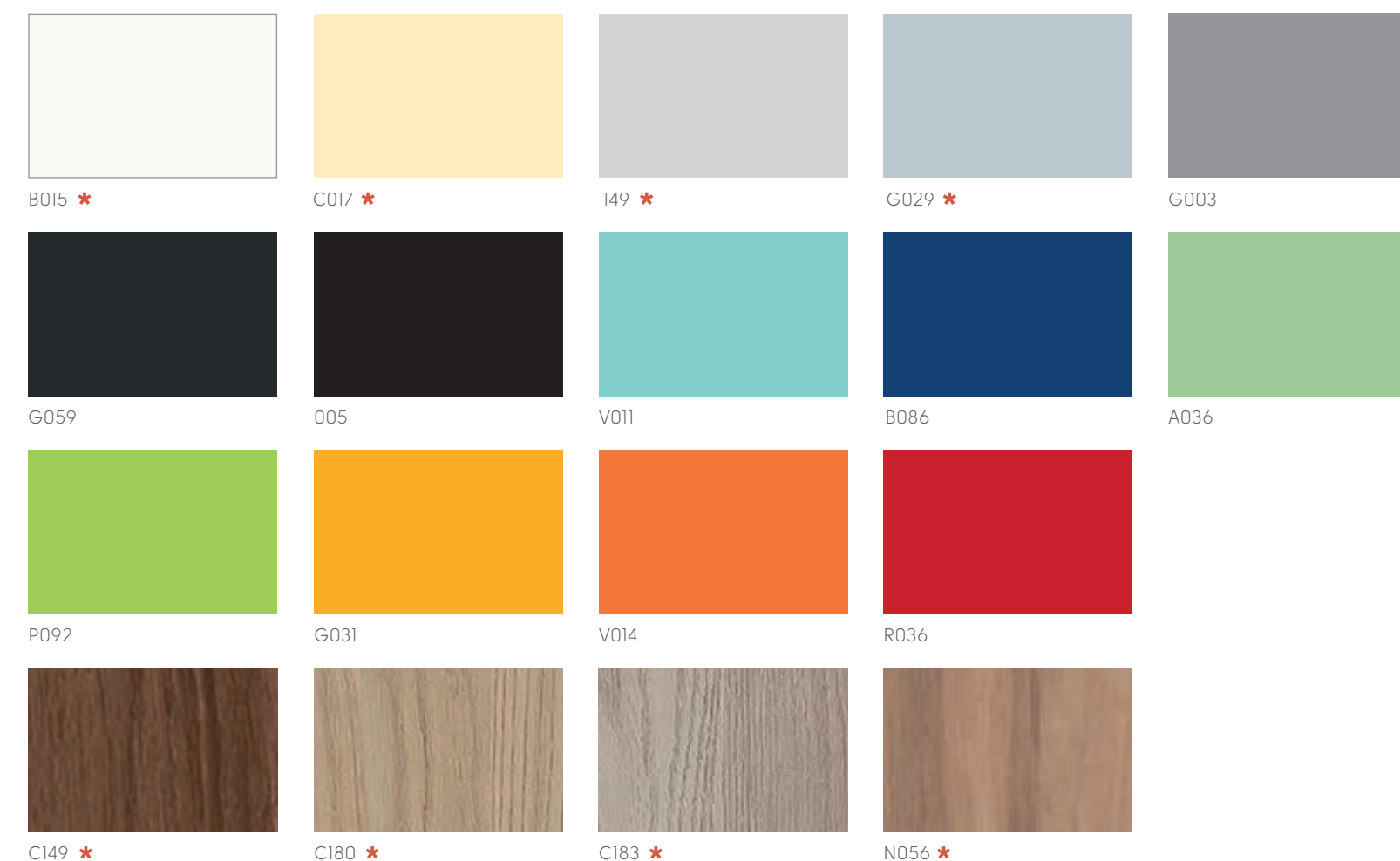

* Possível aplicação no exterior | Posible aplicación en el exterior | Application possible à l'extérieur | Possible application outdoor | Geeignet für den Außenbereich

TOPPLUS

ALTO BRILHO

ALTO BRILLO
HAUTE BRILLANCE
HIGH GLOSS
HOCHGLANZ



As cores e dimensões apresentadas neste catálogo são meramente indicativas
Los colores y dimensiones presentados en el catálogo son solamente para ejemplificación
Les couleurs et dimensions présentées dans le catalogue sont seulement pour exemplification
The colours and dimensions presented in the catalogue are just exemplifying
Die farben und größen im katalog sind nur exemplarisch

Nova coleção de tampos fabricados com termolaminado alto brilho "TOP PLUS - by redi", com mais do dobro da resistência ao risco, ao desgaste e a abrasão que o brilho tradicional. O termolaminado tem 1,2 mm de espessura, para conferir um brilho excelente, sem marcas sem imperfeições, o que lhe dá um aspecto cristal mas com a resistência e vantagens do termolaminado. TOP PLUS com uma espessura de 20 mm e com o canto ABS de 1 mm bi-color é um produto de máxima qualidade e design que revolucionará o mercado de tampos para hotelaria.

Nueva colección de tableros fabricados con el laminado alto brillo "TOP PLUS - by redi", con más de doble de resistencia al roce, al desgaste ya la abrasión que el brillo tradicional. Tiene un grosor de 1,2 mm de espesor para conferirle un brillo excelente, sin imperfecciones, pero con la resistencia y las ventajas del laminado. TOP PLUS con un grosor de 20 mm se fabrica con canto ABS de 1 mm bi-color. Un producto de máxima calidad y diseño que revolucionará el mercado de tableros para hostelería.

La nouvelle collection de plateaux en stratifié d'haute brillance "TOP PLUS - by redi", avec le double de la résistance aux rayures, à l'usure et à l'abrasion, que la brillance traditionnelle. Le strat de 1,2 mm d'épaisseur donne une excellente brillance sans traces ni défauts, un aspect d'un cristal mais avec une résistance d'un strat. Le plateau fait au totale 20 mm d'épaisseur avec un chant ABS de 1 mm bicouleur. Un produit de qualité supérieure et un design qui va révolutionner le marché des plateaux pour l'hôtellerie.

A new table tops collection, produced with high gloss laminate "TOP PLUS - by redi", with more than double of strength to the risk and abrasion than the traditional. The laminated with 1,2 mm thickness, ensuring an excellent bright, without marks or imperfections, what gives an appearance and advantages to the laminated. TOP-PLUS table top with a thickness of 20 mm and border in ABS of 1 mm bi-color, is a product of high quality and design that comes revolutionize the Contract market.

Eine neue Tischplattenkollektion, hergestellt mit Hochglanzlaminat „TOP PLUS - by redi“, mit mehr als der doppelten Abriebfestigkeit gegenüber traditionellen Laminat. Mit einer Stärke von 1,2 mm bringt es hervorragenden Glanz ohne Mängel und Unvollkommenheiten hervor. Die TOP-PLUS Tischplatte mit einer Stärke von 20 mm und einem zweifarbigen ABS-Rand von 1 mm ist ein Produkt von hoher Qualität und Design, das den Objektmarkt revolutionieren wird.

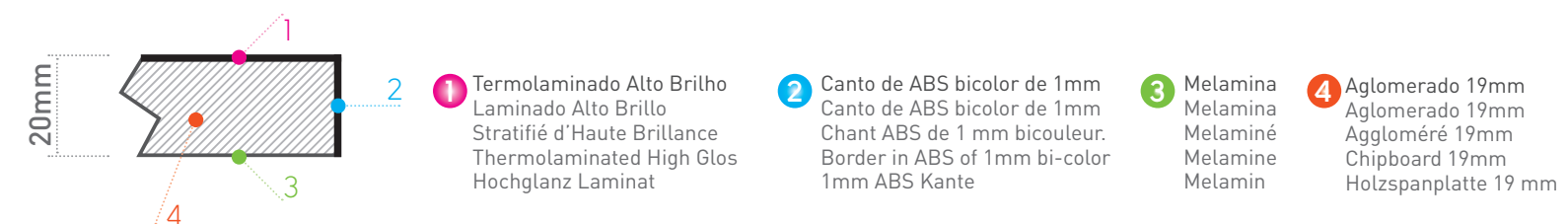

CORES DISPONÍVEIS | COLORES DISPONIBLES | COULEURS DISPONIBLES | AVAILABLE COLORS | VERFÜGBARE FARBEN



FAIA VELATURA | HAYA CON COLOR | HÊTRE TEINTÉ | STAINED BEECH | BUCHE GEBEITZT



As cores e dimensões apresentadas neste catálogo são meramente indicativas
 Los colores y dimensiones presentados en el catálogo son solamente para ejemplificación
 Les couleurs et dimensions présentées dans le catalogue sont seulement pour exemplification
 The colours and dimensions presented in the catalogue are just exemplifying
 Die farben und größen im katalog sind nur exemplarisch

PELE SINTÉTICA | PIEL SINTÉTICA | PEAU SYNTHÉTIQUE | SYNTHETIC LEATHER | KUNSTLEDER

A ATLANTIS



PELE SINTÉTICA | PIEL SINTÉTICA | PEAU SYNTHÉTIQUE | SYNTHETIC LEATHER | KUNSTLEDER

B ALMA



PRETO

PELE SINTÉTICA | PIEL SINTÉTICA | PEAU SYNTHÉTIQUE | SYNTHETIC LEATHER | KUNSTLEDER

B EQUADOR



CHARCOAL

As cores e dimensões apresentadas neste catálogo são meramente indicativas
 Los colores y dimensiones presentados en el catálogo son solamente para ejemplification
 Les couleurs et dimensions présentées dans le catalogue sont seulement pour exemplification
 The colours and dimensions presented in the catalogue are just exemplifying
 Die farben und größen im katalog sind nur exemplarisch

MICRO FIBRA | MICRO FIBRA | MICRO FIBRE | MICROFIBER | MIKROFASER

B MANILA



TOFFEE



EBONY

BEIGE

CAMEL

CUOIO

SIENA



ELEPHANT

SAND

LIGHT GREY

DARK GREY

BLACK



BORDEAUX

PELE SINTÉTICA | PIEL SINTÉTICA | PEAU SYNTHÉTIQUE | SYNTHETIC LEATHER | KUNSTLEDER

C PANTANAL



VERMELHO 01086023

GELO 01086009

ENCARNADO 01086003

TERRA 01086022

GRENAT 01086010

NACAR 01086015

BLEUET 01086021

MAÇA 01086014

PRATA 01086006

CREME 01086011

ATTOLL 01086008

EUCALIPTO 01086002

CINZA 01086024

NATURAL 01086016

NOITE 01086004

BAMBU 01086025

CHUMBO 01086007

ARGILA 01086017

AMARELO 01086005

PRUNE 01086019

PRETO 01086001

CASTANHA 01086012

CHOCOLATE 01086018

FUCHSIA 01086020

CITRINO 01086013

As cores e dimensões apresentadas neste catálogo são meramente indicativas
 Los colores y dimensiones presentados en el catálogo son solamente para ejemplificación
 Les couleurs et dimensions présentées dans le catalogue sont seulement pour exemplification
 The colours and dimensions presented in the catalogue are just exemplifying
 Die farben und größen im katalog sind nur exemplarisch

TECIDOS | TEJIDOS | TISSUS | FABRICS | STOFFE

C BOA



CHOCOLATE BRANCO CHAMPANHE CINZA PRETO

C TEXAS



CAMEL SAND WHITE TAUPE

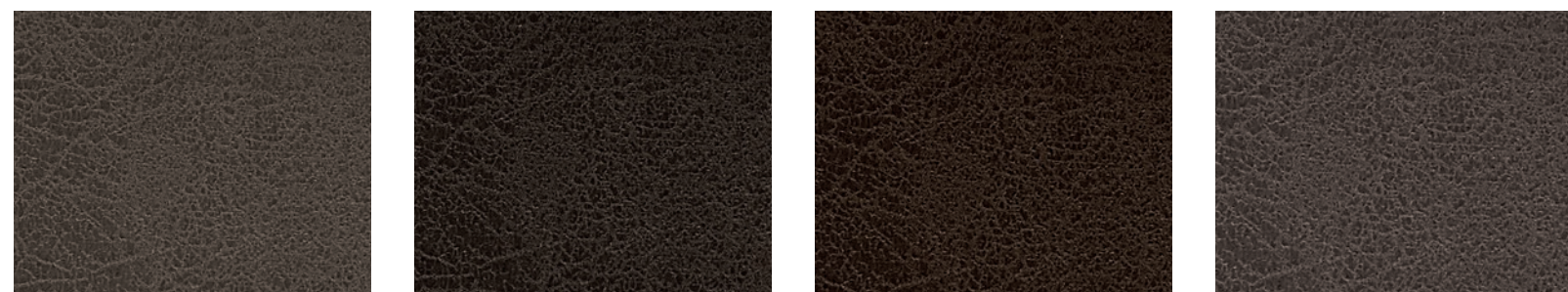

ELEPHANT EBONY CHOCOLATE SIENA

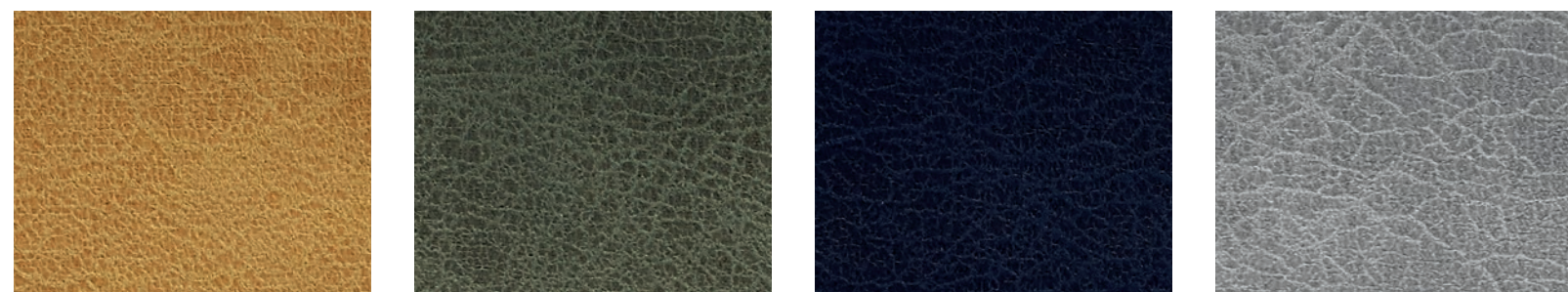

MOSTAZA GREEN BLUE ASH

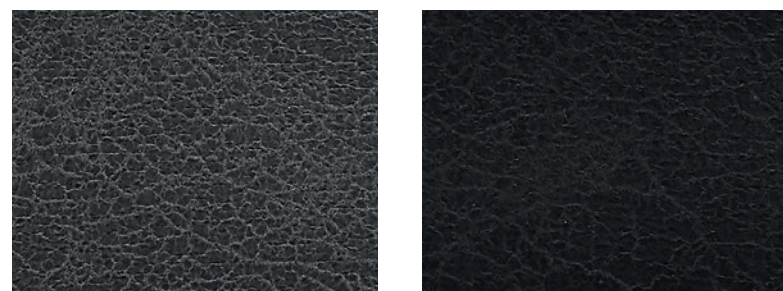

DARK GREY BLACK

As cores e dimensões apresentadas neste catálogo são meramente indicativas
 Los colores y dimensiones presentados en el catálogo son solamente para ejemplificación
 Les couleurs et dimensions présentées dans le catalogue sont seulement pour exemplification
 The colours and dimensions presented in the catalogue are just exemplifying
 Die farben und größen im katalog sind nur exemplarisch

PELE SINTÉTICA | PIEL SINTÉTICA | PEAU SYNTHÉTIQUE | SYNTHETIC LEATHER | KUNSTLEDER

D PUNTOS

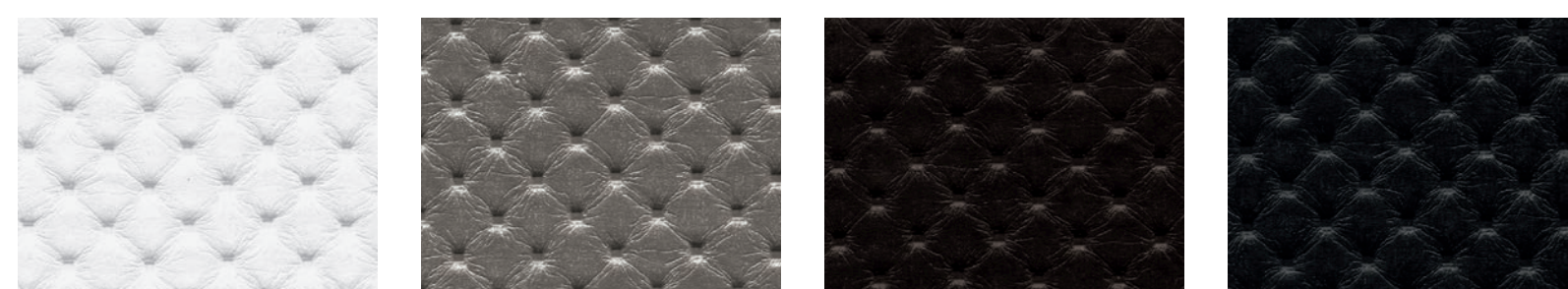

BRANCO IRON CHOCOLATE PRETO

D MONTE CARLO



ANTRACITE

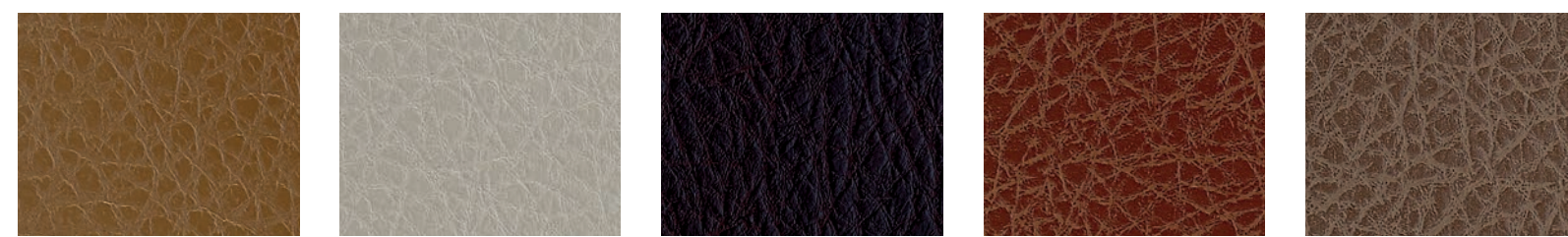

MOSTAZA BEIGE BURGANDY CUOIO CLAY

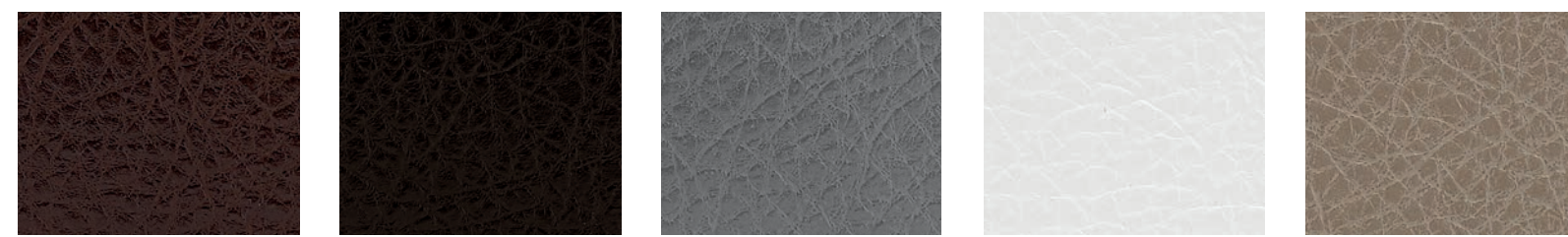

BROWN EBONY ASH WHITE KHAKI

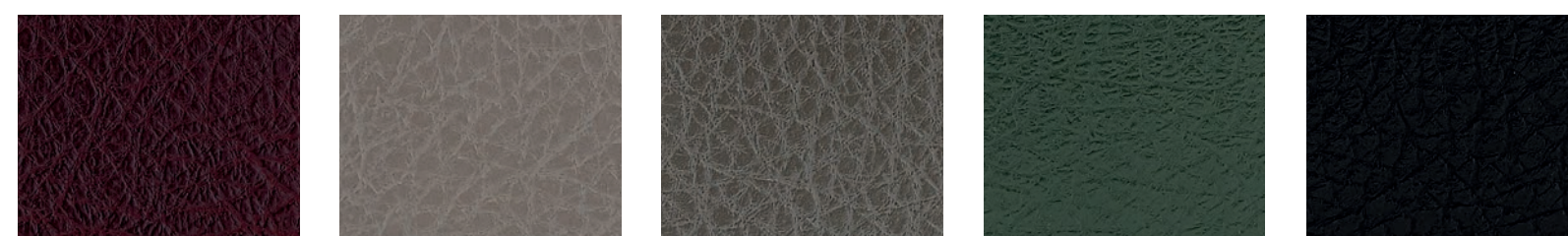

BORDEAUX TAUPE ELEPHNT GREEN BLACK

E SELECT



G INCA

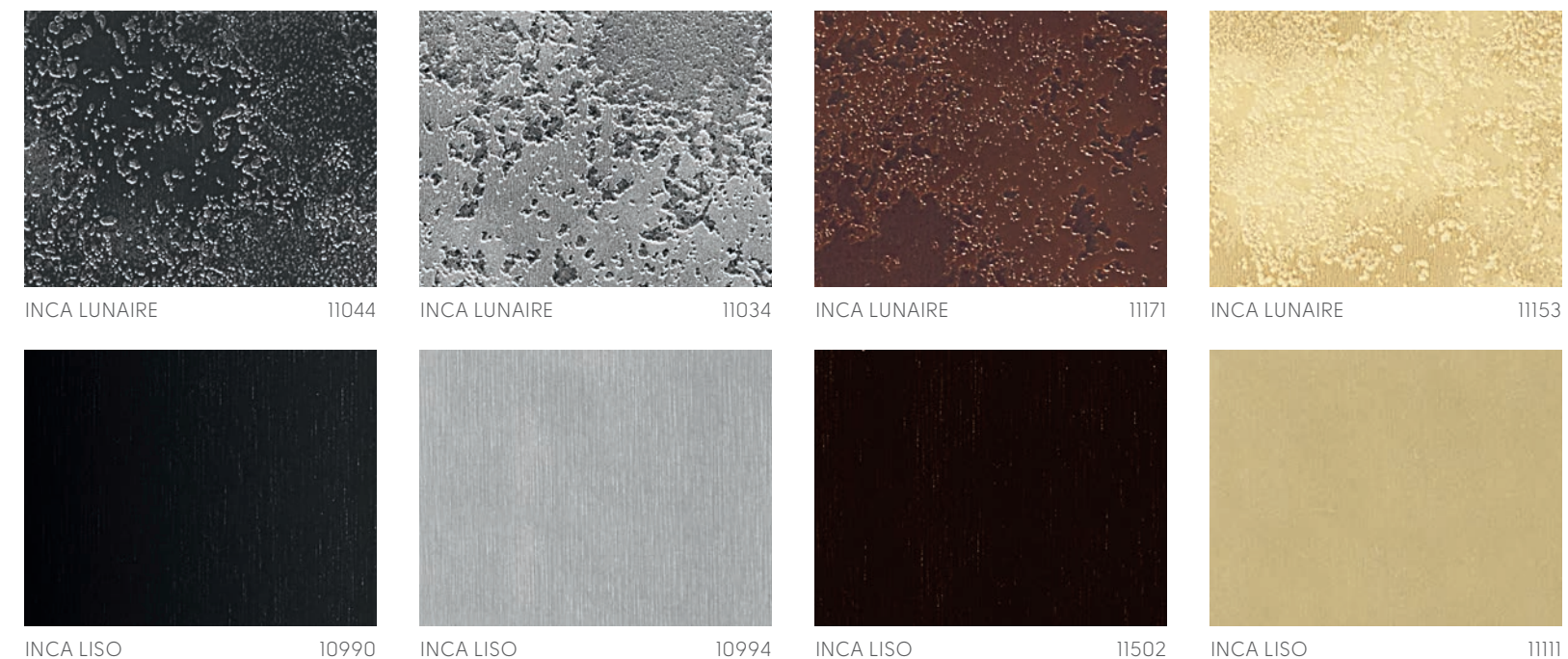

As cores e dimensões apresentadas neste catálogo são meramente indicativas
 Los colores y dimensiones presentados en el catálogo son solamente para ejemplificación
 Les couleurs et dimensions présentées dans le catalogue sont seulement pour exemplification
 The colours and dimensions presented in the catalogue are just exemplifying
 Die farben und größen im katalog sind nur exemplarisch

NEW | FUSION



NEW | FUSION



As cores e dimensões apresentadas neste catálogo são meramente indicativas
 Los colores y dimensiones presentados en el catálogo son solamente para ejemplificación
 Les couleurs et dimensions présentées dans le catalogue sont seulement pour exemplification
 The colours and dimensions presented in the catalogue are just exemplifying
 Die farben und größen im katalog sind nur exemplarisch

I GINKGO

				
MYRTILLE 01332045	TURQUOISE 01332047	BLANC 01338019	ENDIVE 01332032	MIRABELLE 01332021
				
CITROUILLE 01338015	PETROLE 01332060	SEIGLE 01332027	MENTHE 01332042	DUNE 01332023
				
TOMETTE 01332014	NUIT 01332011	MASTIC 01332013	GRANI 01332052	CAPUCCINO 01332038
				
GROSEILLE 01332026	LAVANDE 01332009	TERRE 01332048	AMANDE 01332020	CHÂTAIGNE 01332003
				
TOMATE 01332044	TAUPE 01332043	VERT 01332006	CAFÉ 01332049	PIVOINE 01338025
				
QUETSCHÉ 01338007	SOURIS 01338004	AIGUE MARINE 01332012	CHOCOLAT 01332001	BEGONIA 01332046
				
LILAS 01332008	PIERRE 01332050	GLACIER 01332059	ANTHRACITE 01332002	MORGON 01338016

 K LARA

			
LARA 110 PACIFIC	ZEST 110 PACIFIC	ASTON 151 TEAL	LARA 151 TEAL
			
LARA 111 PEACOCK	ZEST 151 TEAL	BROOKLAND 911 STEEL	LARA 904 PEWTER
			
BROOKLAND 108 DELPH	ASTON 116 NAVY	LARA 903 CHARCOAL	ZEST 906 ASH
			
BROOKLAND 900 BLACK	LARA 209 WASABI	BROOKLAND 209 WASABI	ASTON 904 PEWTER
			
LARA 252 WILLOW	LARA 919 ZINC	BROOKLAND 252 WILLOW	ASTON 226 LIME

TECIDOS | TEJIDOS | TISSUS | FABRICS | STOFFE

NEW K LARA



LARA 800 BEIGE



LARA 954 GRAPHITE

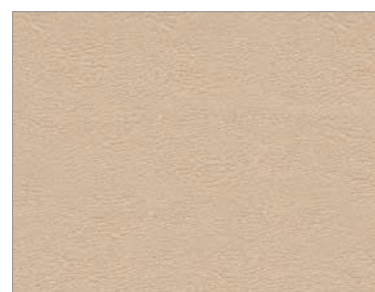

ASTON 823 CHABLIS



ASTON 807 MUSHROOM



LARA 905 DOVE

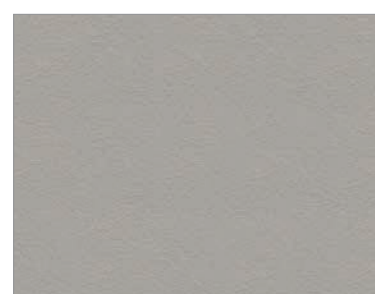

ASTON 905 DOVE

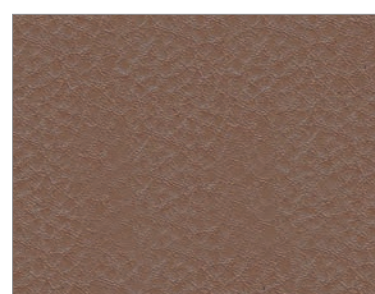

BROOKLAND 801 TAN

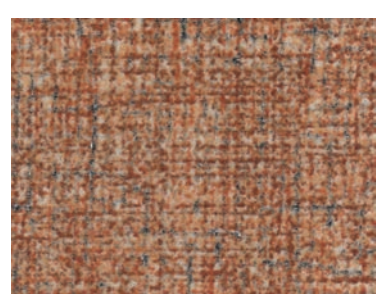

LARA 447 CINNAMON



LARA 858 COBBLE

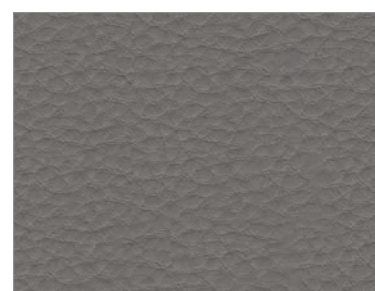

BROOKLAND 501 SMOKE

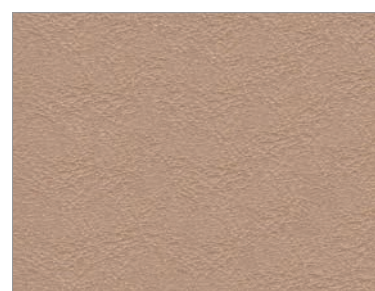

ASTON 877 OYSTER

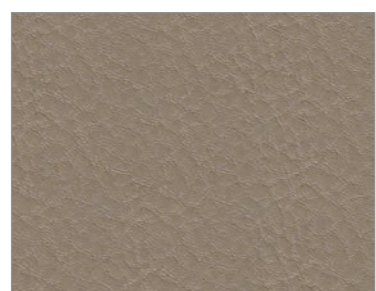

BROOKLAND 822 HIDE GREEN



BROOKLAND 807 MUSHROOM

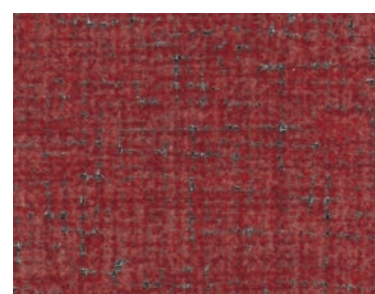

LARA 444 CHERRY



LARA 807 MUSHROOM

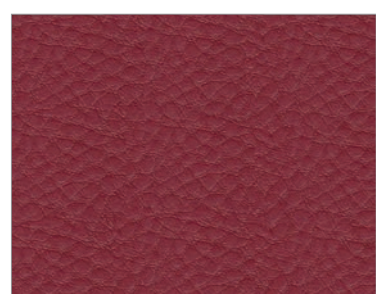

BROOKLAND 444 CHERRY



ZEST 424 VERMILLION

As cores e dimensões apresentadas neste catálogo são meramente indicativas
 Los colores y dimensiones presentados en el catálogo son solamente para ejemplificación
 Les couleurs et dimensions présentées dans le catalogue sont seulement pour exemplification
 The colours and dimensions presented in the catalogue are just exemplifying
 Die farben und größen im katalog sind nur exemplarisch

TECIDOS | TEJIDOS | TISSUS | FABRICS | STOFFE

NEW K SOLINO



WHITE

F5076054



LIGHTBEIGE

F5076055

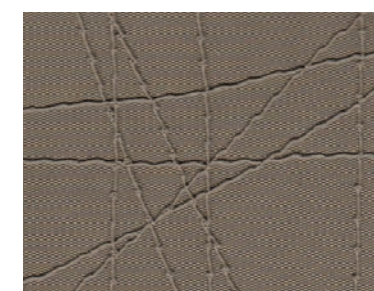

BIRCH

F5076056

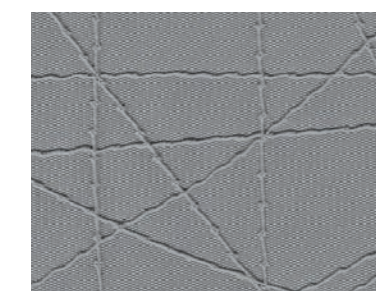

SILVERGREY

F5076060

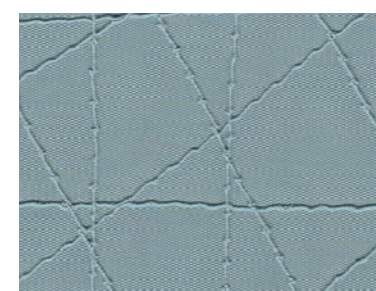

GLACIER

F5076057

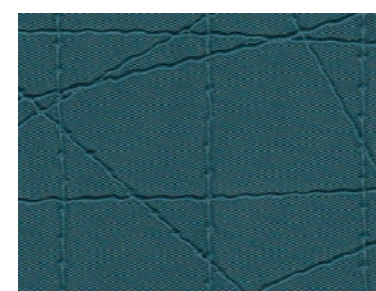

PETROL

F5076086

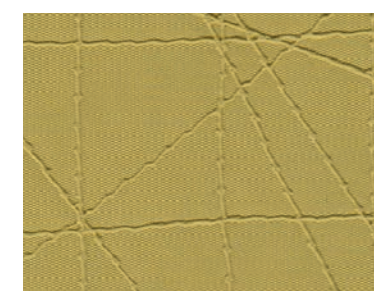

LEMON

F5076084

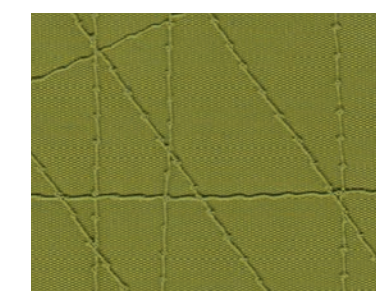

LIME

F5076058



CHERRY

F5076059

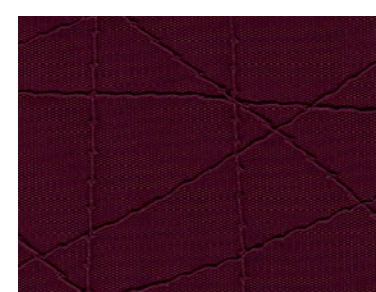

RASPBERRY

F5076085



ANTHRACITE

F5076061



BLACK

F5076064



SHERRY

F5076062

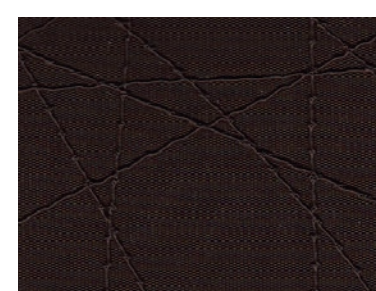

CHOCO

F5076063

As cores e dimensões apresentadas neste catálogo são meramente indicativas
 Los colores y dimensiones presentados en el catálogo son solamente para ejemplificación
 Les couleurs et dimensions présentées dans le catalogue sont seulement pour exemplification
 The colours and dimensions presented in the catalogue are just exemplifying
 Die farben und größen im katalog sind nur exemplarisch

PELE SINTÉTICA | PIEL SINTÉTICA | PEAU SYNTHÉTIQUE | SYNTHETIC LEATHER | KUNSTLEDER

M CORTIÇA | CORCHO | LIÈGE | CORK | KORK



ORACLE

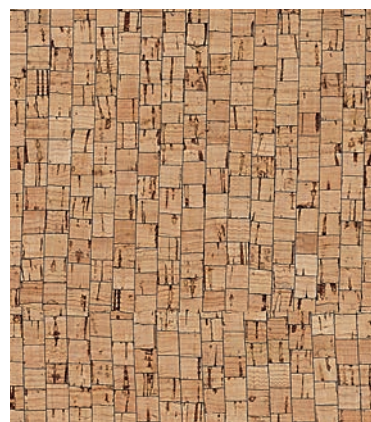

MORPHEUS



TRINITY



LEMON

As cores e dimensões apresentadas neste catálogo são meramente indicativas
 Los colores y dimensiones presentados en el catálogo son solamente para ejemplificación
 Les couleurs et dimensions présentées dans le catalogue sont seulement pour exemplification
 The colours and dimensions presented in the catalogue are just exemplifying
 Die farben und größen im katalog sind nur exemplarisch

METAL | METAL | MÉTAL | METAL | METALL

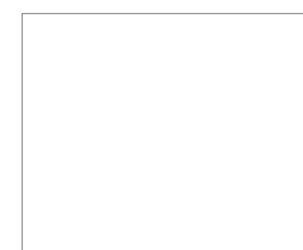

3000 BRILHO

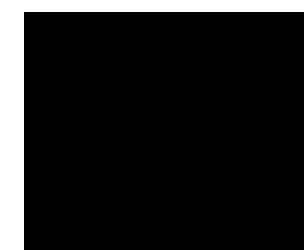

3014 BRILHO

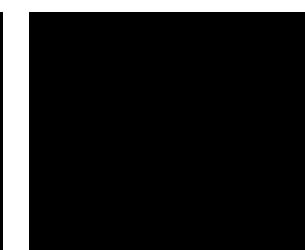

3015 MATE



3016 TEXTURADO

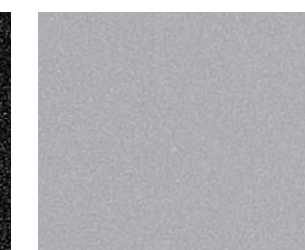

3018

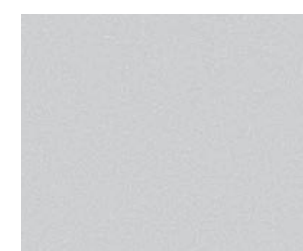

3019

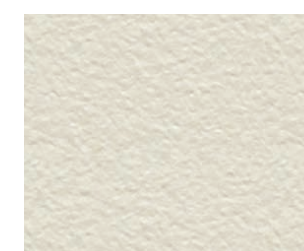

3030 TEXTURADO



3032 MATE

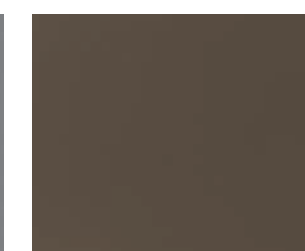

3034 MATE

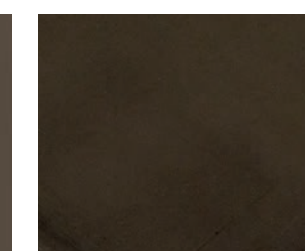

3040 VERNIZ

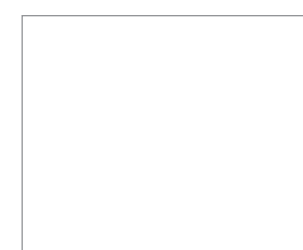

3042 MATE



3046



3048

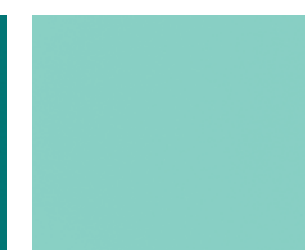

3050 MATE



3052



3054



3056 MATE



3058 MATE



3060 MATE



3062 MATE

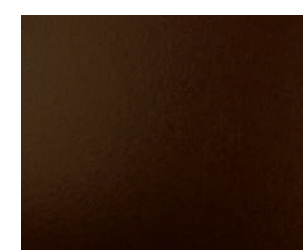

3063

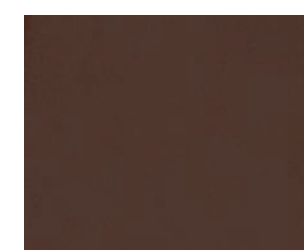

3064 MATE

METAL | METAL | MÉTAL | METAL | METALL

PINTURA ESPECIAL | PINTURA ESPECIAL | PEINTURE SPÉCIALE | SPECIAL PAINT | SONDERFARBTON



3070

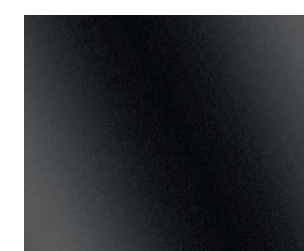

3072



3074



3076

DIMENSÕES MESA/N.º LUGARES

DIMENSIONES MESA | N.º PERSONAS | DIMENSIONS TABLE | N.º PERSONNES | DIMENSIONS TABLE | NUMBER OF SEATS | ANZAHL DER SITZPLÄTZE

